

NES

Electric Service Guidelines Version 18

Published by Nashville Electric Service
Effective Date: August 15, 2019



TABLE OF CONTENTS

| | |
|--|-----------|
| CHAPTER I: GENERAL INFORMATION | 4 |
| INTRODUCTION | 4 |
| OBTAINING SERVICE TO A SINGLE RESIDENCE OR NEW RESIDENTIAL SUBDIVISIONS..... | 6 |
| OBTAINING SERVICE TO A NEW COMMERCIAL ACCOUNT | 6 |
| SITE PLAN REQUIREMENTS..... | 7 |
| FREQUENTLY ASKED QUESTIONS | 8 |
| INSPECTIONS AND ELECTRIC CODES..... | 13 |
| SERVICE RATINGS..... | 13 |
| USEFUL PHONE NUMBERS..... | 14 |
| COMPARISON OF OVERHEAD AND UNDERGROUND SERVICE..... | 15 |
| RIGHT OF WAY..... | 16 |
| ALL WEATHER ROAD..... | 16 |
| REPAIR & MAINTENANCE | 17 |
| CHAPTER II: TEMPORARY SERVICE | 18 |
| BASIC INFORMATION ABOUT TEMPORARY SERVICES..... | 18 |
| STEP 1: SET UP ACCOUNT & APPLY FOR SERVICE | 19 |
| STEP 2: PURCHASE TEMPORARY METER BASE..... | 19 |
| STEP 3: INSTALL TEMPORARY SERVICE EQUIPMENT..... | 19 |
| STEP 4: OBTAIN ELECTRICAL RELEASE FOR TEMPORARY SERVICE | 20 |
| STEP 5: PAY ANY REQUIRED FEES AND/OR DEPOSITS | 20 |
| STEP 6: NOTIFY NES WHEN TEMPORARY SERVICE IS NO LONGER NEEDED..... | 20 |
| CHAPTER III: RESIDENTIAL SERVICE | 23 |
| SUMMARY OF REQUIRED STEPS..... | 23 |
| APARTMENTS AND OTHER MULTI-UNIT DWELLINGS..... | 24 |
| MANUFACTURED AND MODULAR HOMES | 24 |
| STEP 1: SET UP ACCOUNT AND REQUEST SERVICE | 24 |
| STEP 2: DESIGN DISTRIBUTION SYSTEM..... | 25 |
| STEP 3: INSTALL METER BASE AND OTHER SERVICE EQUIPMENT..... | 25 |
| STEP 4 (OH): SITE PREPARATION FOR OVERHEAD SERVICE | 26 |
| STEP 4 (UG): SITE PREPARATION FOR UNDERGROUND SERVICE..... | 28 |
| CHAPTER IV: COMMERCIAL SERVICE | 44 |
| SUMMARY OF REQUIRED STEPS..... | 44 |
| STEP 1: ESTABLISH ACCOUNT AND REQUEST SERVICE..... | 45 |
| STEP 2: DESIGN DISTRIBUTION SYSTEM..... | 47 |
| STEP 3: INSTALL METER BASE AND OTHER SERVICE EQUIPMENT..... | 47 |
| STEP 4(OH): SITE PREPARATION FOR OVERHEAD SERVICE..... | 47 |
| STEP 4(UG): SITE PREPARATION FOR UNDERGROUND SERVICE..... | 50 |
| CHAPTER V: METERING | 65 |
| METERING REQUIREMENTS LOOK-UP TABLE | 67 |
| INDIVIDUAL SINGLE PHASE SELF-CONTAINED METER BASE REQUIREMENTS..... | 68 |
| UNDERGROUND METER BASE REQUIREMENTS | 68 |
| CLASS 320 METER BASE REQUIREMENTS..... | 68 |
| CLASS 320 UNDERGROUND REQUIREMENTS..... | 68 |
| MULTI-FLOOR & HIGH RISE METERING | 72 |
| METER TROUGHS AND TERMINATION ENCLOSURES..... | 74 |
| INDIVIDUAL THREE-PHASE SELF CONTAINED METER BASE REQUIREMENTS..... | 75 |
| CURRENT TRANSFORMER (CT) RATED METER BASE REQUIREMENTS..... | 76 |
| SWITCHGEAR METERING..... | 80 |
| MULTIPLE METER INSTALLATIONS ("GANG METERS")..... | 82 |
| APPENDIX | 84 |
| APPENDIX A: LIGHTING | 84 |
| APPENDIX B: LEGENDS USED ON NES DRAWING | 86 |
| APPENDIX C: SAFETY CLEARANCES..... | 91 |
| APPENDIX D: ADDITIONAL INFORMATION..... | 104 |
| BOLLARD/GUARD POST | 110 |
| EQUIPMENT WARNING LABEL..... | 111 |
| COMMUNICATION RISER REQUIREMENTS..... | 112 |
| PRE-CONSTRUCTION FORM (SAMPLE COPY)..... | 116 |
| CONTRACTOR PICK-UP INFORMATION | 117 |
| OVERVIEW OF CHANGES..... | 118 |



CHAPTER I: GENERAL INFORMATION

INTRODUCTION

The Electric Service Guidelines (Customer Handbook) have been thoughtfully and carefully laid out for the Customer's use. Please become familiar with them before beginning a project. The word "Customer" in this publication refers to the landowner or developer. Many steps will actually be completed by contractors or electricians, but the ultimate responsibility rests with the Customer.

Additional requirements may apply to certain projects which will be handled on an as needed basis.

The Electric Service Guidelines include:

- Temporary Service: services used while building a permanent structure, or for a period of one year or less.
- Residential Development: services to new subdivisions, apartments, town homes, condominiums or mobile home parks.
- Individual Residences: services for individual home builders, and modular/manufactured homes on permanent foundations that are not part of a park.
- Commercial and Industrial Services: services to permanent commercial or industrial structures, outbuildings on residential property (barns, shops, pump-houses, garages, etc.), or any three-phase service whether it is for residential or commercial use.



The most recent version of the Electric Service Guidelines may be accessed at nespower.com - select *Builders & Contractors, Guidelines & Manuals*, and then select the appropriate document. Other useful publications may be found in the *Guidelines & Manuals* section of the website such as those listed below.

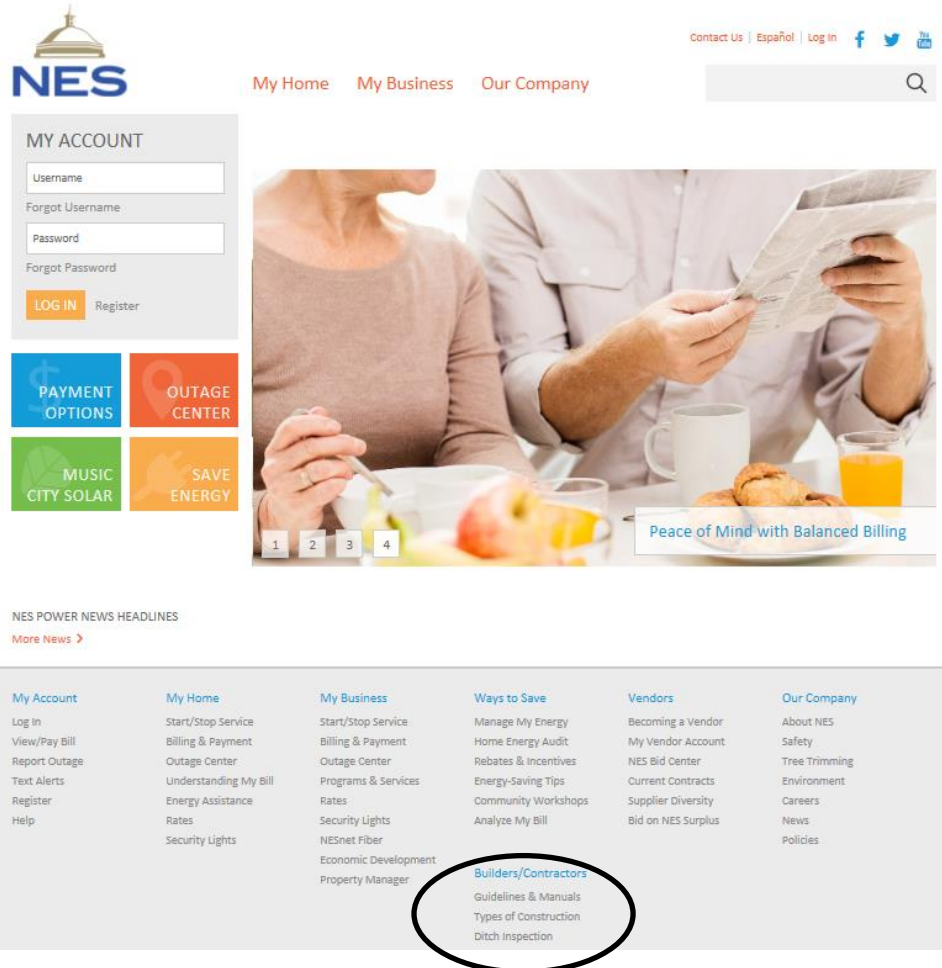

NES STREET LIGHT DESIGN MANUAL: Selection of luminaires and poles available for installation and maintenance by NES.

NES DOWNTOWN NETWORK SERVICE GUIDELINES: This is the governing document of guidelines for services within the Downtown Underground Network Service Area.

POLE ATTACHMENT AND CONDUIT USAGE GUIDELINES: Covers the installation of Communication Cables, Wireless Equipment, Banners and Seasonal Equipment on NES Poles and in NES Conduits.



Electric Service Guidelines

OBTAINING SERVICE TO A SINGLE RESIDENCE

Call Customer Service at (615)736-6900 for assistance with obtaining service to a residence.

OBTAINING SERVICE TO NEW RESIDENTIAL SUBDIVISIONS

The first step is to complete the *Residential Application for Service* (see Appendix page 110 and 111) available for download at nespower.com or by calling (615)747-3775.

Once completed, the application should be faxed to 615-747-3552 or mailed to:

Nashville Electric Service
Energy Services Engineering
Room 200
1214 Church Street
Nashville, TN 37246

An Energy Services Engineering (ESE) job owner will contact you to confirm receipt of the application. Once all the necessary information is received, the ESE job owner works directly with NES Customer Engineering to obtain a preliminary layout. It usually takes eight weeks to obtain a preliminary layout.

Customer Engineering then sends the cost estimate and preliminary drawing to ESE. Once the preliminary layout is agreed upon between NES and the developer, two to three weeks is required to finalize the cost estimate. ESE will then draft a *Residential New Business Agreement* and determine if a Contribution in Aid to Construction (CIAC) will be required. The estimate must be finalized, a *Residential New Business Agreement* must be signed and any CIAC must be paid before utility construction begins.

CONTRIBUTIONS IN AID TO CONSTRUCTION

New residential subdivisions must generate enough electric revenues to offset estimated construction costs. The CIAC is determined by comparing the estimated cost to serve the subdivision to a revenue allowance which is based on the electric load information provided by the developer. The developer is responsible for paying any difference in these estimates before the work is scheduled for construction. If the estimated cost is less than the revenue allowance a CIAC is not required. Revenue allowances are higher for all-electric homes.

Relocations of electric facilities due to the construction of the subdivision shall be paid in advance of construction. This includes, but is not limited to, road widening and pole relocations due to clearance (safety) issues.

Once all contractual and financial issues are resolved, the job is released to construction. If necessary, a pre-construction meeting will be scheduled shortly after the job is released for construction.

OBTAINING SERVICE TO NEW COMMERCIAL ACCOUNTS

CONTACT ENERGY SERVICE ENGINEERING @ (615)747-3775 OR
CUSTOMER SERVICE @ (615)736-6900.



SITE PLAN REQUIREMENTS

The following information is needed before NES can engineer the electrical layout:

- Site plans (both a hard copy and digital copy)
 - The digital copy shall be provided on a compact disk (Civil Information).
 - The format shall be AutoCAD dwg.
 - The drawing shall not contain X-refs.
 - The drawing shall be registered to the TN State Plane Coordinate System, North America Datum 1983 (NAD83).
 - Data shall be arranged in separate layers and labeled for identification.
- Street names
- Building setbacks/envelopes shown on drawings.
- Twenty-foot (20') easement adjacent to roads on a Final Plat.
- Proposed grading start date.
- Permanent energize service date.
- Grading plans.
- Proposed location and dimensions for sidewalk/grass strips.
- Decision whether primary and service will be overhead or underground.
- Water and sanitary sewer plans.
- Storm water plans.
- Fire hydrant locations.
- Street lighting plans.
- Stream crossings and bridge requirements.
- Any three-phase power requirements.
- Plans for any secondary terminations enclosures (troughs not allowed, see page 78).
- Location of any electric or dry-type vault rooms.
- Planned Road Improvements (i.e. turning lanes or lane improvements).
- Developer's vegetation design shall meet NES Vegetation Management requirements/clearances.

Easement Note:

If porches or walls are allowed to be constructed beyond the minimum setback limits and into the public utility easements; then the easement will be considered reduced by that much of the easement. Such encroachments may increase the cost of electrical infrastructure to allow for reduced or limited access to equipment. NES reserves the right to enter and to erect, maintain, repair, rebuild, operate and patrol electric power overhead and underground conductors and communications circuits with all necessary equipment reasonably incident thereto including the right to clear said easement and keep the same clear of brush, timber, inflammable structures, buildings, permanent structures, and fire hazards; all over, under, upon, and across the easement as granted on any plats.



Electric Service Guidelines

FREQUENTLY ASKED QUESTIONS

Question: *Is there a special phone number for contractors to call Customer Service (to place business orders and check on order status)?*

Answer: Yes - (615)747-3443.

Question: *How long will my job take?*

Answer: Your project clock begins once the items listed in the next question are completed. NES needs approximately four (4) weeks to engineer a single pole-to-pad-mounted transformer job and approximately eight (8) weeks to engineer the layout for a subdivision. The time needed for the crew to complete construction once the engineering is done varies too widely to estimate. The amount of time depends on weather, equipment availability, number of new business jobs, etc.

All items listed on the following question affect the time needed to complete your job. The number one delay to establishing service is incomplete and/or incorrect information. Time can be minimized by placing the order with NES early, by ensuring the same address is used on the codes release as was used to place the order, by alerting your account representative immediately if there are any changes that affect the electric system such as service rating, relocation of buildings, streets, etc, and by making any required payments or deposits promptly.

Question: *What do I have to do before NES starts construction?*

Answer: Complete the following:

1. Enter into a formal agreement (Contract for Electrical Service) with NES (Pay deposit if required).
2. Furnish NES Energy Services Engineering job owner with site plans (see page 7 for details) that are approved and recorded as required by the applicable County Planning Commission.
3. Pin and stake the lot lines.
4. Provide graded, usable all-weather roads where electric lines will go. Before poles or anchors can be set, site needs to be at or within 12" of finished grade.
5. Record the easements (or sign an agreement to furnish and record easements).
6. Pour the foundation, or provide other evidence of new home construction.
7. Pay any required Contribution in Aid to Construction (CIAC).
8. Complete any required vegetation removal.



Question: *What if the panel size needs to be changed after the order is placed?*

Answer: Let your NES Engineering contact know immediately. If the NES crew arrives to energize the service and discovers the panel size is not the same as the one indicated on the job drawing, or is different from the one inspected by Codes, it will delay the installation of service. If the difference in panel sizes is not noticed by the NES crew, voltage problems or outages could result.

Question: *Why is the street address so important, and where do I get it?*

Answer: The street address is used to match the NES order to the Codes release. Contact your county Codes official to obtain a valid street address.

Question: *What situations do not require a release?*

Answer: An Electrical Release is not required if you are:

- Replacing meter blocks
- Replacing meter base with same amperage base, and NO wire is being replaced
- Replacing or reattaching conduit, or changing out weather-head
- Changing out hub
- Reattaching point of attachment
- Replacing breakers

Question: *When do I need an Electric Release?*

Answer: An Electrical Release is required if you are:

- Replacing conductor with new conductor (this includes Customer's underground conductor)
- Adding additional load (changing the panel size)
- Relocating a service or building a new service
- Service has been de-energized over one year

Question: *When is a change meter order required?*

Answer: A change meter order is required if you you have existing service and you are:

- Adding additional load (changing the panel size)
- Relocating a service
- Replacing an existing service
- Replacing conductor with new conductor (this includes Customer's underground conductor)

Question: *Do I need to request a Temporary Service while remodeling?*

Answer: Vacant homes and occupied homes being remodeled may use existing service to remodel if windows and doors are lockable to insure safety, and the existing service is not in the way of construction. Otherwise, a temporary service will be required.



Electric Service Guidelines

Question: *How do I schedule a planned outage and reconnect of my meter base for situations that do not require a codes release?*

Answer: Planned outages are to be worked during normal business hours Monday through Friday only. Customer or electrician must notify the Customer Service section of NES at (615)736-6900 prior to work being performed. Customer Service will assist you in coordinating a schedule with the appropriate operations department(s).

Question: *How do I change my existing overhead service to underground?*

Answer: For an individual, this may require paying NES for the associated costs (removing pole and overhead equipment, installation of underground conductor and equipment). Additionally, the Customer is responsible for providing the trenching and conduit for the underground service. For a subdivision, participants shall agree on a method for cost-sharing the estimated cost. All Customers being served from poles that are being replaced with underground facilities must be willing to change to underground service, even if they are not participating in the cost-sharing. These costs shall be paid before construction begins.

Question: *Will NES move a pole and if so, who pays for it?*

Answer: If a pole is moved at the Customer's request, the Customer is charged the actual construction costs. Also, suitable easements or property rights shall be provided with no cost to NES.

Overhead Service

Question: *How much slack do I need to leave for NES to make up the drip loop?*

Answer: A minimum of twenty-four inches (24") of slack is required to make the drip loop.

Question: *Can I build underneath my residential service entrance?*

Answer: Only if you keep three feet and six inches (3'-6") clearance between an inaccessible roof and the service line.

Question: *What is the required clearance over a deck?*

Answer: Service lines shall be eleven feet (11') above deck floors (see page 92).

Question: *Can my service line go over my hot tub (or swimming pool)?*

Answer: No. Refer to Figure 44 on page 93 for more details of clearances from swimming pools and waterways.

Question: *How close can my driveway be to an NES pole?*

Answer: The minimum separation distance is twelve inches (12") however, NES recommends at least three feet (3'-0") to avoid damage to the driveway when



the pole is replaced.

Question: *Can I place the point of attachment above the weatherhead? (Frequently asked for billboards)*

Answer: Most billboards are on state road or interstate right-of-ways, meaning electrical inspections are done by the State Codes Inspector. The State Codes Inspector has allowed attachments above weatherheads, as long as they meet the National Electric Code (NEC) requirement of twenty-four inches (24") maximum distance between the point of attachment and the weatherhead. Different counties may have different rules. Check with your local Codes inspector (page 14) for situations not on state road or interstate right-of-ways.

Underground Service

Question: *When will I get my pad sketch?*

Answer: Directions for the installation of concrete pads are distributed with all other contractor requirements during the Pre-Construction meeting. General pad sketches are provided on pages 61 and 62 to give contractors an idea of the space and materials needed. Construction of the pad shall not begin until the final pad sketch is presented during the Pre-Construction Meeting.

Question: *Do I dig the ditch for underground, or does NES?*

Answer: The Customer is responsible for excavation and conduit including Duct Bank Systems and Manholes. (See page 30 for residential requirements, or page 52 for commercial requirements.)

Question: *Can phone, cable TV and power go in the same secondary ditch to the house?*

Answer: Only if there is a one-foot (1') vertical and horizontal spacing between the NES cables and the other utility cables. (See page 30 for residential requirements, or page 52 for commercial requirements.)

Question: *Can I put a condenser over my underground service?*

Answer: No. NES requires the lines not be located under any planned permanent structures to ensure timely maintenance and repairs.

Question: *Who owns the conduit?*

Answer: Once a residential service is energized NES owns and maintains the distribution conduit and cable. The Customer owns residential service conduit whether it is from a pad-mounted transformer or a pole-type transformer, and NES owns the cable. The Customer owns, maintains and locates the service cable and conduit of commercial services from pad mounted transformers. The Customer owns commercial service conduit from a pole-type transformer; NES owns the conductor. See page 17 for more details.



Electric Service Guidelines

Metering

Question: *Can I use a 400 amp self-contained meter base?*

Answer: A class 320 (self-contained) meter base may be used for residential service or single phase commercial temporary service.

Question: *Can I place the meter base directly onto a mobile home?*

Answer: A manufactured or “mobile” home Customer SHALL install a Customer-owned pole (refer to Figure 28 on page 69 or Figure 29 on page 70 for specifications). The meter base may only be installed directly on a “modular” home if the tongue is removed and the home’s manufacturer has certified that the building is rated for such an installation.

Question: *Does my manufactured home, mobile home or modular home qualify as “permanent living quarters?”*

Answer: The variety of situations that can occur makes it difficult to give a black-and-white definition. The rule of thumb is, if it would be easy to reattach the wheels and relocate, it is not a permanent living quarters. A manufactured home installed on a solid foundation is a clear case of permanent living quarters.

Question: *Do I have to install the ground wire all the way up and out of the weatherhead?*

Answer: The ground wire shall be installed in accordance with your local Codes. Please contact your local Codes inspector for this information. (see Contacts on page 14).

Relocate Overhead to Underground Electric System

Any relocation of facilities from overhead (OH) to underground (UG) must allow for future circuit needs as deemed by NES. All costs of relocating OH to UG including easements shall be on the requestor as stated in the NES Electric Service Policies Manual.

NES will consider requests for burying segments of our distribution system. Such requests will be evaluated on a case by case basis and will be evaluated on the following engineering and operational considerations: Employee and Public Safety, System Reliability, System loading (Capacity), Future maintenance and accessibility, Future Growth.

NES in its discretion will determine how going underground will affect current conditions or future plans for our system. To ensure the reliability of NES’s system, NES may require that additional manholes, switches, etc. be installed in addition to what is required to serve a specific planned development.

All requests for converting OH circuits to UG must be in writing and shall include justification and a sketch/drawing of the proposed UG route associated with the development. Each request will be presented to an internal NES team for review and comment. Such meetings are regularly scheduled on a monthly basis. In some cases, a system study may need to be performed before a response is provided.

Contact **Energy Services Engineering (ESE)** 615-747-3775 to submit official requests to convert primary overhead facilities to underground.

Contact Customer Relations 615-736-6900 to submit official requests to convert individual residential facilities from overhead to underground.



INSPECTIONS AND ELECTRIC CODES

This handbook should be used as a guide for meeting NES requirements. It does not cover all federal, state and local code requirements. It is the Customer's responsibility to ensure the project complies with the most recently adopted version of National Fire Prevention Association's National Electrical Code (the NEC) and any other federal, state or local codes that apply. Once the Customer's service equipment is installed, and any site preparation has been completed, it is the Customer's responsibility to contact the local Electrical Codes Inspection agency. Once the installation has passed the Codes inspection, it is the Codes Inspector's responsibility to send a copy of the release to NES. It is the Customer's responsibility to follow up with Codes if the release has not been received by NES.

Once NES receives a release from Codes, confirms that all deposits and fees have been paid, and the engineering design is completed, a construction crew will be scheduled to install the electrical facilities.

! Codes release shall have the same address as the Customer gave when the application for service was requested. Discrepancies between the two addresses will cause a time delay in the release process. The Customer shall be responsible for correcting any discrepancies.

SERVICE RATINGS

The size of service depends upon the size of the building and the power requirements of the equipment installed in it. The Customer is responsible for determining power requirements for the installed equipment. The following standard types of services are available.

| Single Phase Standard Service Ratings | | |
|---|-------|---|
| Voltage | Wires | Maximum Allowable Demand |
| 120/240 | 3 | 167 kVA Overhead and Underground |
| Three Phase Standard Service Ratings | | |
| 208 grounded wye / 120 (transformer voltage rating is 208Y/120) | 4 | 500 kVA Overhead, 1500 kVA Underground |
| 480 grounded wye / 277 | 4 | 500 kVA Overhead, 2500 kVA Underground |
| 240 delta * | 3 | 500 kVA Overhead, not available Underground |
| 480 delta * | 3 | 500 kVA Overhead, not available Underground |
| 4160 grounded wye / 2400 * | 4 | 1,500 kVA Overhead, 5,000 kVA Underground |
| * This voltage rating is only available to customers with services already at this voltage. | | |
| Primary Voltage Standard Service Ratings (Engineering Department shall approve use of these voltages for service requirements) | | |
| 13,800 | | 3 wire |
| 23,900 grounded wye/13,800 | | 4 wire |
| 69,000 | | 3 wire |
| 161,000 | | 3 wire |

G

Electric Service Guidelines

| USEFUL CONTACTS | | |
|--|--|---|
| NES Contacts | | |
| Customer Service Contractors' Line (All new accounts, residential or commercial) | | 615-747-3443 |
| Energy Services Engineering (Established energy demand Customer accounts) | | 615-747-3775 |
| Meter Department | | 615-747-3805 |
| Street Light Billing and Contracts | Email: streetlighting@nespower.com | 615-747-3531 |
| Private Lighting Section | | 615-747-3775 |
| Attachments Group | Email: attachments@nespower.com | |
| Power Outage or Dangerous Situations | | 615-234-0000 |
| Ditch Inspection | | https://www.nespower.com/DitchInspection.aspx |
| Electric Codes Inspectors | | |
| Davidson County | (After Hours / Weekends call 615-456-9144) Byron Hall | 615-862-6521 |
| Cheatham County | (Tue or Thurs 7AM to 8AM only) | 1-866-407-3421 |
| Fairview | Maurice Holland | 615-351-2228 |
| Robertson County | Mike Taylor | 931-624-6585 |
| Rutherford County | State Inspector | 615-519-6973 |
| Sumner County | State Inspector | Fax request to: 615-264-3605 |
| Williamson County | Scott Mulligan | Fax request to: 615-373-8989 |
| Wilson County | Robbie Mang | 615-449-0370 |
| Property along public highways, streets or roads | Marcus Pipkin | 615-741-7170 |
| Satellite City Street Light Contacts | | |
| Metro/Davidson County | Metro Customer Service | 615-862-8750 |
| Metro Traffic Commission | Mike Hirtzer | 615-456-9682 |
| Belle Meade | Larry Smith | 615-485-8445 |
| Berry Hill | Joe Baker | 615-292-5531 |
| Brentwood | Steve Foster | 615-371-0080 |
| Forest Hills | Brad Bivens | 615-383-8420 |
| Gallatin | Nick Tuttle | 615-451-5965 |
| Goodlettsville | Jeff McCormick | 615-859-2740 |
| Hendersonville | Chip Moore | 615-822-1016 |
| LaVergne | Garlon Russell | 615-793-9891 |
| Millersville | Frank Wilkerson | 615-859-0880 |
| Mt. Juliet | Kenny Martin | 615-754-2552 |
| Oak Hill | Jeff Clawson | 615-371-8291 |
| Ridgetop | Tom Anderson | 615-566-5450 |
| Other Utilities/Metro Departments | | |
| AT&T | Jamie Fuller (Nashville) | 615-916-1087 |
| Comcast | Charles Key Jr. | 615-780-5418 |
| Metro Water/Sewer | Mose Jobe (mose.jobe@ws.nashville.gov) | 615-880-2729 |
| Metro Street Address Assignment | Bonnie Crumby, 720 S. Fifth Street | 615-862-8781 |
| Piedmont Natural Gas (Nashville Gas) | Marketing Dept. | 615-734-0734 |
| TDS Telecom | Russell Harper | 615-641-5088 |
| TDS Telecom LaVergne | Robert Coontz II | 615-589-0677 |
| United Telephone Co | Scott Niehaus | 931-364-4337 |
| TN811 (TENNESSEE ONE CALL) | | |
| State law requires you notify utilities of your intent to dig through TN811 (Tennessee One Call) Call BEFORE digging | Phone: | 811 |
| | Fax: | 615-366-5102 |

COMPARISON OF OVERHEAD AND UNDERGROUND SERVICE

The two types of electrical service available are overhead and underground. Local ordinances such as the one enacted May 17, 2005 in Davidson County may require underground service. It is the Customer's responsibility to be aware of and follow local codes and ordinances. More details of the Davidson County ordinance can be found on the Internet at http://www.nashville.gov/mpc/ordinances/bl2005_628.htm.

If the existing primary lines are installed underground, the service shall also be installed underground. In areas where existing service is provided by overhead lines, the Customer may choose either overhead or underground.



Figure 1A: Pad-mounted Equipment (Underground System)



Figure 1B: Utility pole (Overhead System)

The main difference to the Customer is site preparation. For overhead service, the Customer shall acquire the right-of-way and or easements for any new poles, guys, or other equipment that must be set to provide service. In addition, the customer must remove vegetation to clear the path for the new line. For underground service, the Customer is responsible for acquiring the right-of-way and or easements for pad-mounted equipment, digging and backfilling trenches, providing and installing conduit and ground wire and pouring pads for underground equipment. Commercial customers are also responsible for providing and installing underground service wire from a pad mounted transformer.

Advantages of Overhead Service:

- Equipment and cable costs less
- Easier to connect new Customers
- Equipment uses less ground space
- Outages take less time to repair
- More flexibility – easier to increase capacity, relocate equipment

Advantages of Underground Service:

- Less tree trimming (but shrubbery must be cleared around pad-mounted equipment)
- No poles or guy-wires near drive-ways or other Customer property
- Can serve larger loads (very large transformers are too heavy for poles)
- Less chance of storm outages



Electric Service Guidelines

RIGHT OF WAY

! The Customer shall provide all necessary easements, rights-of-way, and tree trimming at NO COST to NES before any line extension is constructed or service is provided. For easement guidance/questions send an email to Property@nespower.com

NES will confine its facility installations to existing rights-of-way, public property or easements whenever possible, except for service conductors.

NES installs poles and equipment on the side of the road wherever possible. This ensures timely maintenance and repairs in the future. Roadside construction minimizes the occurrence of property damage by NES trucks when making repairs or doing maintenance. If NES equipment or primary riser poles are more than fifteen feet (15') from a paved surface, or otherwise deemed inaccessible by NES trucks, the Customer is responsible for installation of an all-weather road as shown in Figure 2 below. This road is required so NES crews can access the equipment when future service restoration and maintenance is necessary.

Drawing Notes:

1. Notification of need for road will be given during the Pre-Construction Meeting.
2. Twenty-five-foot (25') minimum radius of turn on road curves.
3. Install drainage structures as needed.
4. All weather roads greater than fifty feet (50') will be approved at NES engineer discretion.
5. Slope at equipment operating position shall be limited to 6%.
6. Paved road may be required at NES discretion.
7. NES shall refuse to energize service until required all weather road is provided.

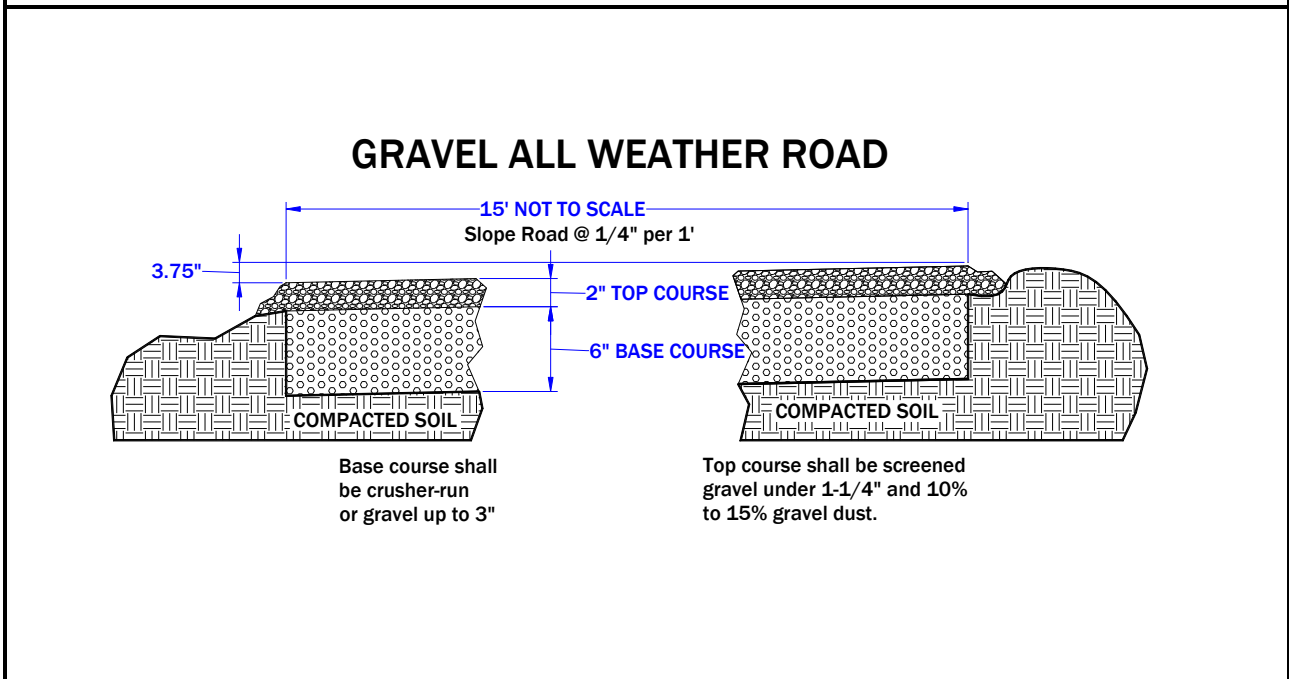

Figure 2: All Weather Road



REPAIR & MAINTENANCE

Services

Overhead Services (Residential and Commercial):

The Customer is responsible for repairs on the load side of the service connectors, including the weatherhead, service mast and meter base. NES is responsible for maintenance and repairs on the source side of the service connectors, including the actual service connectors.

Underground Services:

Primary Conduit (residential or commercial): NES owns and maintains all primary conduits and cable no matter who installed it. The Customer is responsible for furnishing and installing the conduit, Duct Banks, and Manholes. NES is responsible for maintaining and repairing the conduit and cable.

Service Conduit from pad-mounted transformer (residential): The Customer owns the residential service conduit. NES owns and maintains the conductor and will locate the service. The Customer is responsible for repairing damage to conduit that does not affect the cable. The Customer will be asked to uncover the conduit as needed in the case of a dig-in outage. NES will repair the conduit if the cable is also damaged.

Service Conduit from pad-mounted transformer (commercial): The Customer owns, locates, maintains and repairs commercial service conduit and cables. NES does not own, locate, maintain or repair commercial service conduits or cables.

Service Conduit from pole-type transformer (residential or commercial): The Customer owns the service conduit from a riser pole. NES owns and maintains the cable, and will locate the service. The Customer is responsible for repairing damage to conduit that does not affect the cable. The Customer will be asked to uncover the conduit as needed in the case of a dig-in outage. NES will repair the conduit if the cable is also damaged.

Street Lights

For street lights that need maintenance, call (615)736-6900. or visit the Street Lighting Website. <http://www.nespower.com/securitylight.aspx>

Home Renovations/Additions

If a meter is made inaccessible after installation (for example if a sunroom is built next to the wall with the meter base) the Customer will bear the cost for moving the metering facilities to an accessible outside location approved by NES Engineering.



Electric Service Guidelines

CHAPTER II: TEMPORARY SERVICE

! Safety is a high priority. NES will not connect service wire to attachment hardware deemed unsafe, such as screw knobs. If NES sees an unsafe condition or violation of Codes, the service will be disconnected even if the Customer has a release.

! Temporary service meters cannot be attached to an existing NES pole, a tree, or a building.

! Contractors building in subdivisions should stencil the lot number on the support stake. This will ensure the temporary service is connected at the correct location.

BASIC INFORMATION ABOUT TEMPORARY SERVICES

A service is considered temporary if:

- It serves new construction before the installation of permanent service.
- It serves a construction trailer.
- The service is needed for 12 months or less.
- The service is seasonal such as Christmas tree stands.

Service to mobile homes are considered temporary if:

- They are not owned by the Customer.
- They do not have permanent connection to a water or sewer line.
- They are not installed as permanent living quarters.

A connection fee shall be paid before the temporary service is energized.

NES does not build new primary lines to a temporary service. There shall be signs of construction (such as the building foundation), and a permanent service order shall be placed, before a new line will be built to provide service to a temporary meter.

The only standard voltage for temporary service is 120/240 Volts single phase, three wire, supplying a service of 200 Amps or less. Non-standard service voltages are charged as a total “in-and-out” cost (total labor with overhead and indirect charges to install and remove the service, plus the cost of any non-reusable materials), but will not be any less than the standard temporary connection fee.

Temporary services are billed at the appropriate commercial rate.



STEP 1: SET UP ACCOUNT & APPLY FOR SERVICE

Call the Customer Service Call Center at (615) 736-6900. For temporary service larger than 200 amps contact energy services at (615) 747-3775. New Contractors or Customers will need to set up an account, which may include a deposit.

Once an account has been set up, an NES representative places an order. The NES representative (“rep”) will request general billing information, the address for the new service, and discuss fees. Refer to the Residential or Commercial section to see what information will be required if permanent service is requested along with temporary.

The temporary service will be served either overhead or underground. If the existing power system in the area is overhead, the temporary service will also be overhead. If the area is served underground, the temporary service will usually come from a previously installed temporary pedestal, as shown in Figure 4 on page 22. Call NES Customer Engineering at (615) 747-3641 for more details.

STEP 2: PURCHASE TEMPORARY METER BASE

The Customer is responsible for providing a meter base with the following specifications:

- Rated 120/240 Volts
- Single phase
- For approved meter bases refer to www.nespower.com under the Builders & Contractors tab.
- Maximum rating of 200 Amps
- Four jaws
- Underwriters Laboratory (UL) approved
- Ringed Type

Any vendor that can meet the above requirements is acceptable. Vendors who are known to supply NES approved meter bases are:

STEP 3: INSTALL TEMPORARY SERVICE EQUIPMENT

| | | |
|--|---|---|
| CED 330 19 th Avenue North Nashville, TN 37203 (615) 329-2601 | Graybar Eighth Avenue South Nashville, TN 37203 (615) 254-8484 | Harris Electric Supply 656 Wedgewood Ave. Nashville, TN 37202 (615) 255-4161 |
| Utilicor (Power & Tel) 3412 Ambrose Ave. Nashville, TN 37207 (615) 226-0321 | Wesco 1400 Ft. Negley Blvd. Nashville, TN 37203 (615) 248-9713 | Williams Wholesale Supply 831A Cowan Street Nashville, TN 37207 (615) 324-0469 |

Temporary services shall comply with the National Electrical Codes (NEC) and National Electrical Safety Code (NESC). Temporary services are subject to inspection by the local Codes Inspector (see Contacts on page 14). Service will not be scheduled to be energized until an electrical release is received by NES. Check with NES Customer Engineering if there are plans to do anything differently from what is shown in Figure 3 or Figure 4, p. 21, 22 or if there are any questions. Deviations can result in a delay in receiving service, or in service being denied.



Electric Service Guidelines

STEP 4: OBTAIN ELECTRICAL RELEASE FOR TEMPORARY SERVICE

! Temporary service will not be energized until the final release is received by NES. Do not relocate the temporary after the service has been energized. Any relocation of the temporary AT ANY TIME requires a new Codes release.

Contact the local Codes Inspector. The appropriate Codes Inspector will forward a certified release to notify NES that the service is approved.

If the temporary is relocated after it has been inspected, a new inspection and release is required. NES may reject the service, or remove NES's service wire at a later date, if the temporary is deemed unacceptable by NES or by Codes.

STEP 5: PAY ANY REQUIRED FEES AND/OR DEPOSITS

Once Customer has paid all fees and deposits, NES will design temporary service. Once NES receives a release from Codes, temporary service will be scheduled for installation.

STEP 6: NOTIFY NES WHEN TEMPORARY SERVICE IS NO LONGER NEEDED

To have temporary service disconnected, contact NES Customer Service at (615)736-6900.

Examples of acceptable means of attachment.

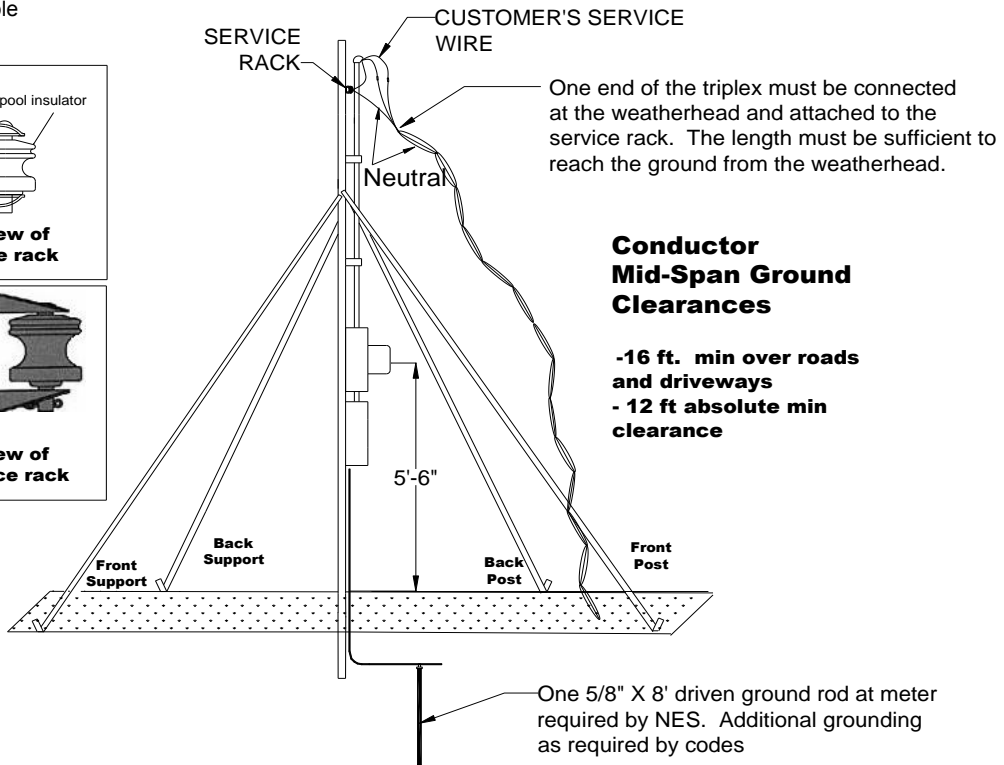
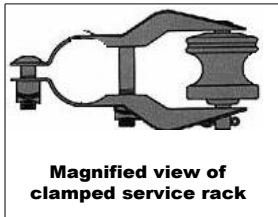
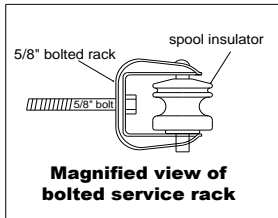

Drawing Notes:

1. The service pole shall be of sufficient height to provide required conductor clearances of sixteen feet (16') over roads and driveways. For lines crossing land that will not be subject to traffic of any kind (including vehicles, trucks, and horseback riders), the absolute minimum clearance is sixteen feet (12'). The service rack shall be attached at an elevation such that the lowest point of the conductor meets these clearances. See figure 53 on page 102.
2. Pole shall be located on the lot for which service is requested. Distance from NES pole or NES conductor to Customer's temporary pole shall be at least ten feet (10') and no more than one hundred and twenty-five feet (125'). If a distance greater than one hundred and twenty-five feet (125') is required, contact NES Customer Engineering for approval prior to construction. A taller, heavier class post with additional bracing might be required.
3. Pole shall be constructed of such material and installed at a sufficient depth to stabilize the temporary meter base. Conductor shall be shielded by riser conduit from base to weather head.
4. Service line shall not cross property belonging to others. If line will cross other's property, Customer shall obtain an easement for NES.
5. Customer shall clear a path through trees or brush that is wide enough to allow utility service personnel to run the line, and to allow lines to hang without contacting trees or limbs.
6. Where practical, pole should be set at least thirty feet (30') behind existing or proposed sidewalk or curb line to avoid conflicts with new poles and anchors. Otherwise, the temporary pole may require relocation at a later date.
7. Aluminum conductor is required for triplex service wire ("pigtail"). Conductor shall be shielded by riser.
8. Neutral shall be attached to service rack by wedge clamp.

Figure 3: Overhead Temporary Service Installation

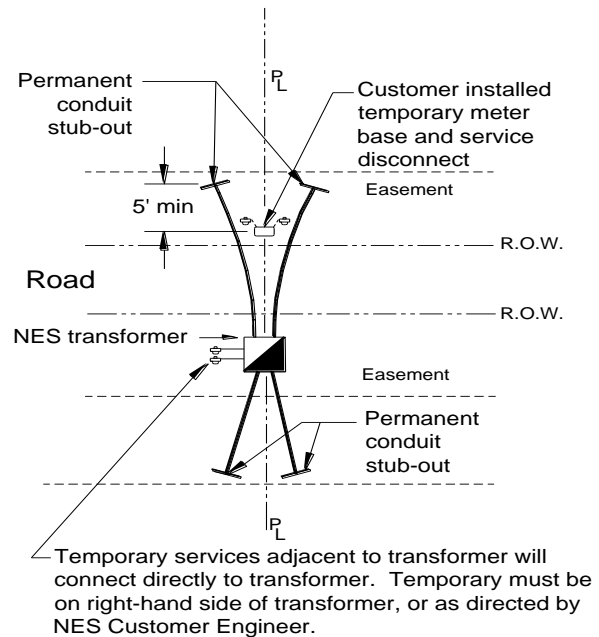
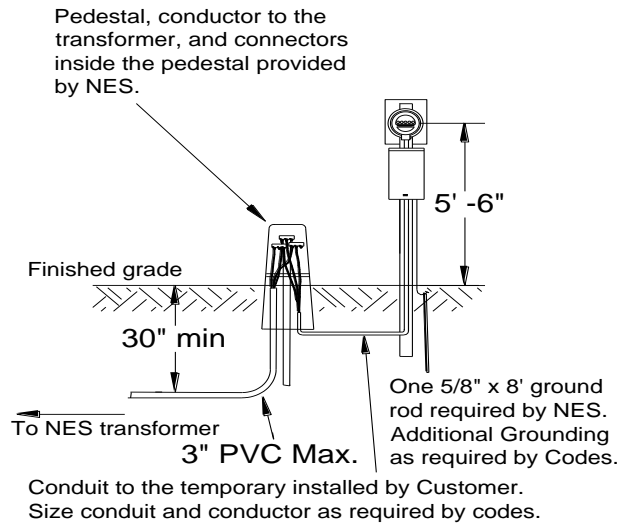
Drawing Notes:

1. Temporary shall be located within the easement and on the same side of the street as the property being served. The temporary shall be approximately three to ten feet (3' - 10') from the transformer or temporary service pedestal.
2. Temporary shall be on the secondary side of the transformer (right-hand side as viewed facing the transformer door).
3. If the connection point is a stub-out, NES requires a twenty-four-inch (24") square excavation at the stub-out. Leave five feet (5') of extra wire at the stub-out.
4. If the connection point is a pull box or transformer, the Customer needs to trench to the right side (facing transformer or pull box with back to road), and leave the conduit exposed. If any other conductors are discovered while digging, leave them covered. Leave five feet (5') of extra wire at a pull box, ten feet (10') of extra wire at a transformer.
5. Contact NES C&M Section (615)747-3113 to coordinate the installation of temporary service conductors into pedestal or transformer.
6. Conduit to the temporary installed by Customer.
7. Size conduit and conductor as required by Codes.
8. Street Lighting shall not be connected to or served from a temporary pedestal.
9. A ringed type meter base is required for temporary services.

Figure 4: Underground Temporary Pedestal Installation



CHAPTER III: RESIDENTIAL SERVICE

SUMMARY OF REQUIRED STEPS

| Overhead primary and secondary | Furnish | | Install | | More details on pgs: |
|--|----------------|-----------|-------------|---------|----------------------|
| | Customer | Utility | Customer | Utility | |
| Set up account, place order with NES | X | | N/A | | 24 |
| Tree trimming | X | | N/A | | 26 |
| Weatherhead/Meter base (<i>location determined by NES</i>) | X | | X | | 25, 67 |
| Customer-owned pedestal or pole (<i>if required</i>) | X | | X | | 69-70 |
| Conductor from meter base into building | X | | X | | 11,17,27 |
| Codes release to NES | X | | X | | 13 |
| Secondary conductors (<i>transformer to meter</i>) | | X | | X | 27 |
| Meter | | X | | X | 67, 68 |
| Overhead primary, underground secondary | Furnish | | Install | | More details on pgs: |
| | Customer | Utility | Customer | Utility | |
| Set up account, place order with NES | X | | N/A | | 24 |
| Tree Trimming if required | X | | N/A | | 26 |
| Secondary trenching and backfill | X | | X | | 29-42 |
| Meter base (location determined by NES) | X | | X | | 25, 67-68 |
| Customer-owned pole or pedestal (<i>if required</i>) | X | | X | | 69-70 |
| Secondary conduits | X | | X | | 29 - 31 |
| Codes release to NES | X | | X | | 13,14 |
| Secondary conductors to meter/CT cabinet | | X | | X | 11,17,33,34 |
| Meter | | X | | X | 67-68 |
| Underground primary and secondary | Furnish | | Install | | More details on pgs: |
| | Customer | Utility | Customer | Utility | |
| Set up account, place order with NES | X | | N/A | | 24 |
| All trenching and backfill | X | | N/A | | 29-42 |
| All conduits (1 and 3 phase) | X | | X | | 30-42 |
| Transformer pad box (1 phase) or | | X | X | | 37 |
| Transformer concrete pad (3 phase) | X | | X | | 61,62 |
| Equipment bases (<i>if required</i>) | | X | X | | 104-107 |
| Equipment protection (<i>if required</i>) | X | | X | | 108-109 |
| Meter base (location determined by NES) | X | | X | | 25, 67-68 |
| Primary conductors | | X | | X | 36 - 40 |
| Codes release to NES | X | | X | | 13,14 |
| Secondary terminations in transformer | | X | | X | 36 - 39 |
| Current transformer (<i>if required</i>) | Cabinet | CT | Both | | 76-77 |
| Secondary/service conductors (1 phase) | | X | | X | 36,38,39 |
| Secondary/service conductors (3 phase) | X | | X | | 58 |

Note: If NES-supplied items are lost, stolen or damaged, the Customer is responsible for replacement.



Electric Service Guidelines

APARTMENTS AND OTHER MULTI-UNIT DWELLINGS

Multi-unit dwellings should provide proposed meter locations or meter pedestals. Meter troughs are not allowed (see pages 65,74 for more details).

A multi-unit residential-Horizontal Property Regime (HPR) is one containing two or more residential dwelling units on one lot. It may also contain a house meter for common equipment or parking lot lighting.

! All multi-unit residential-Horizontal Property Regimes (HPR) are required to have an underground service lateral to the lot. If more than two units exist, the metering shall be an underground NES-approved, customer-provided, gang meter center. The metering is to be located outside. Contact NES regarding meter specifications and approval of the metering location before starting installation of the service.

High-rise apartments in the downtown area planning to use 400 amp 125/216 single phase services shall get prior approval from NES Meter Department.

All three phase services are treated as “commercial” for the purposes of this handbook, regardless of how they are classified for billing, zoning, etc.

MANUFACTURED AND MODULAR HOMES

! NES needs information for the entire project, not just the first phase, especially if there will be three-phase equipment.

Modular homes are defined as a house that comes in several pieces which are put together at the home site. The meter base may only be installed directly on a modular home if the tongue is removed and the home’s manufacturer has certified that the building is rated for such an installation.

Manufactured homes (one piece, formerly referred to as “mobile homes” or “trailers”), shall install a Customer-owned pole or pedestal for mounting the meter base. The maximum distance from the building to the pole is thirty feet (30’).

STEP 1: SET UP ACCOUNT AND REQUEST SERVICE

NES will not begin the engineering work or construction for a project until the Customer has established a billing account and paid any required deposits. Contractors or developers building new subdivisions or multi-dwelling units are required to pay a one-time deposit. Individuals can discuss whether a deposit will be necessary, and if so the amount, with a Customer Service Representative.

Once an account is established, contact Customer Service to place an order. The Customer will need to be ready to supply information about the types and sizes of electrical equipment going into each building, the number of lots, apartments etc. Customer Service will process the information. An Energy Services Account Manager may contact the Customer to discuss contract terms, and may schedule a site visit for NES Customer Engineering, who will be responsible for the electrical layout. The Customer will need to provide all easements for NES equipment such as poles, anchors, pad-mounted equipment, etc.

NES recommends making decisions about street lights at this step. It is much more cost effective. For underground service, the street lighting conduit can be installed while the trenches are already opened. For overhead service, NES can allow extra pole height for street light attachments. Only the approved brands and fixtures shown in the **NES Street Light Design Manual** can be maintained by NES.

! Customers who obtain a Codes release before completing Step 1 will encounter delays. NES work is prioritized based on the date an application is made with NES, not on the Codes release date.

STEP 2: DESIGN DISTRIBUTION SYSTEM

The NES Energy Services Account Manager will give the application information to NES Customer Engineering. NES Customer Engineering will design the electrical layout for the residence, including the location of the meter base.

STEP 3: INSTALL METER BASE AND OTHER SERVICE EQUIPMENT

! Do not install the meter base until Customer Engineering has indicated the proper location. The placement of a meter can have a tremendous effect on the cost of the service, and in some cases can make it practically impossible to provide service, necessitating the expense of relocating the meter base. It is much less expensive to wait until the Engineer identifies the location of the meter base.

For approved meter bases refer to www.nespower.com under the Builders & Contractors tab.

The meter base shall be located so it will be accessible to NES personnel. Any exceptions to the requirements shall be in writing, and include the NES employee's signature.

Meter Base:

- **Location shall be approved by Customer Engineering**
- Shall be located on a permanent structure that is controlled by the Customer.
- Shall be located on the side of the building that is closest to normal public access.
- Cannot be mounted in exit stair breezeways (per Metro Fire Marshall).
- Shall be surface mounted (flush-mounted or recessed meter installations are not acceptable).
- Should not be located in an area that is subject to being fenced, such as patios, decks, porches, backyards.
- Should not be located in areas which are susceptible to subsequent enclosure by walls or screens.
- Overhead service shall be located to prevent service wire from crossing a driveway if possible. If a crossing is unavoidable, the point of attachment shall be high enough for the lowest point of the line to be at least sixteen feet (16') above the driveway. Exception: See page 102 figure 53.
- Underground service shall be located so the conductor does not go under any permanent fixture or building, and is in a straight line. One sweeping bend with a fifteen-foot (15') minimum radius is allowed.
- **Meter locations that do not meet NES clearance and access requirements shall be placed on a NES approved meter pedestal.**
- **If a meter(s) is enclosed or otherwise made inaccessible after installation, without written approval from the NES Meter Department, the customer will bear the cost for having the metering facilities moved to an accessible location. Contact NES meter department with any questions prior to construction.**



Electric Service Guidelines

STEP 4 (OH): SITE PREPARATION FOR OVERHEAD SERVICE

4A (OH): Prepare Path from the Existing NES Pole to Customer's Service Mast

The Customer is responsible for trimming and/or removing any tree growing within fifteen feet (15') of the centerline of the future primary power line, and any limbs growing within three feet (3') of the service or secondary power lines. NES will monitor Customer's vegetation growth and when necessary obtain additional clearances.

4B (OH): Install Service Mast

Refer to Figure 5 on page 27.

- When determining the height of the weatherhead, keep in mind that the service conductor can have final sag of up to five feet (5'). There is a Clearance section provided in the Appendix (pages 84-117) to help the Customer understand some of the factors NES Engineers must consider when designing an electrical layout. The Clearance section may also assist development engineers in locating sidewalks, swimming pools, fire hydrants etc.
- Contact the local Codes Inspector with questions (page 14).
- Service mast shall meet all NEC and local Codes. Check with local Codes Inspector for a complete list of Codes requirements.

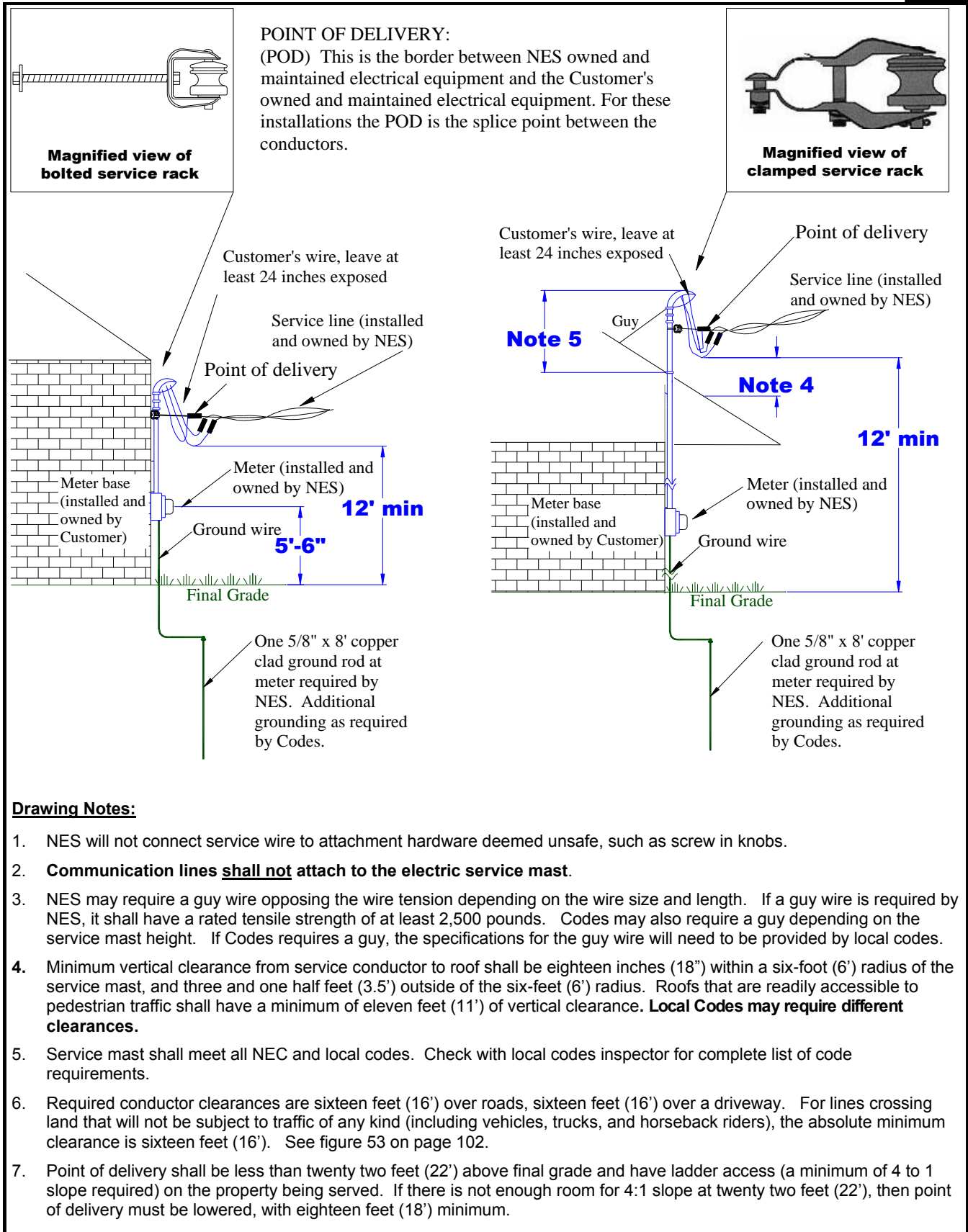

Figure 5: Service Mast Installation



Electric Service Guidelines

STEP 4 (UG): SITE PREPARATION FOR UNDERGROUND SERVICE

! Do not begin any construction related to NES electric service until the Pre-Construction Meeting has been held.

Step 4A (UG): Receive Underground Layout

Once the job has been processed, Customer Engineering will provide a copy to the Customer, along with the name and phone number of the operations supervisor responsible for working the job. The Engineer will usually schedule a formal “Pre-Construction Meeting” to distribute this information, but may waive the meeting in some instances. For example, the second or third phase of a subdivision when there weren’t any miscommunications on the first phase, or underground service served from a pole-type transformer.

The purpose of a Pre-Construction Meeting is to review the requirements in this handbook with the Customer, the NES Energy Services Account Manager, and the NES Operations Supervisor who will be inspecting the Customer’s work for compliance (the “NES ditch inspector”). Depending on the complexity of the job other people may be involved such as NES Metering, the Customer’s electrician, general contractor or subcontractors, other utilities, etc. NES Customer Engineering will have a checklist of issues called the Pre-Construction Meeting Information Sheet. Any exceptions to the requirements in this handbook shall be noted on the Pre-Construction Meeting Information Sheet and initialed by the Customer and an NES employee. The Customer will receive a copy of the Pre-Construction Meeting Information Sheet at the end of the meeting, along with construction drawings.

The Customer should keep the copy of the Pre-Construction Meeting Information Sheet until the project has been completed and energized. This way any discrepancies can be easily resolved.

NES supplies fiberglass pad boxes, and bases for equipment such as primary terminating cabinets if the job requires them. If items supplied by NES are stolen, damaged or lost, the **Customer shall replace supplies at Customer’s expense.**

Step 4B (UG): Dig Trenches

! The NES ditch inspector will not make an inspection until they have received the layout (a drawing) from the NES Engineer. A drawing cannot be made until an order is placed, and all fees have been paid. Following this sequence of steps will ensure your work is handled in a timely manner.

! Customer shall provide room for riser pole on the property that will be served. Pole shall have all proper NESC clearances from other objects on Customer’s property. Pole should be located roadside if at all possible.

! Customer should not begin digging trenches until NES poles have been set. If any digging must be done prior to NES poles being set, digging should stay at least fifteen feet (15’) away from NES stakes. Failure to do so may delay NES installations.



General Trench Requirements

- Trenches shall be free of large or sharp rocks and construction debris.
- Trenches shall meet all Occupational Safety and Health Administration (OSHA) standards.
- Excavated materials shall be kept at least two feet (2') from the edge of the trench.
- Trenches should be in a straight line. (One sweeping bend with a fifteen-foot (15') minimum radius may be allowed.)
- Trenches shall not be located under any planned permanent structures (buildings, condensers, etc).
- There shall be at least twelve inches (12") clearance vertically and horizontally between NES and other utilities' conduits. (Note: If the Customer is building in the Harpeth Valley Utility District or the Hendersonville Utility District, five feet (5') of clearance is required between NES and the water/waste water utilities.)
- The Customer provides all conduit, elbows and items necessary to facilitate the conduit installation. The Customer is responsible for the installation of the conduit system in accordance with NES specifications.

Primary Trenches

- Detailed drawings will be distributed at the Pre-Construction Meeting and will show the locations of all electrical equipment and trenches.
- The embedment and/or backfill material for switch pads, pull-boxes, fiberglass box pads for terminating cabinets and transformers and conduits crossing under roads and other traffic areas is #67 gravel.
- The gravel under equipment shall be filled down to undisturbed soil as well as be below the frost line.
- Where conduits cross under roads or other traffic areas, use only #67 gravel backfill in trenches. Selected backfill is not allowed in these areas.
- Install ground wire, pull boxes, fiberglass pads for terminating cabinets & transformers (pull boxes and fiberglass pads will be provided by NES).
- The Customer will provide any manholes in accordance with NES specifications. The NES engineer will provide the specifications on/or before the pre-construction meeting date.
- For more details on primary trench see Figure 6 page 30.
- The Customer is responsible for all easements, and arranging any road or private property crossings.

Secondary/Service Trenches

- Trench dimensions shall be at least twenty-four inches (24") wide and at least forty-two inches (42") deep. If NES is the only utility, and the conduit is installed such that the written schedule of the conduit is visible, the dimensions may be reduced to six inches (6") wide by thirty-six inches (36") deep, enabling Customer to use a trencher
- FOR SUBDIVISIONS ONLY: Dig trenches from pad-mounted transformers to five feet (5') inside each property line, as shown on detailed drawings provided during the Pre-Construction Meeting (example of trenching detail shown on Figure 15 on page 41).

Residential Customer Ditch Detail for Primary Lines (1) 2-1/2" Diameter Schedule 40 PVC Conduit Single (1) Phase Primary

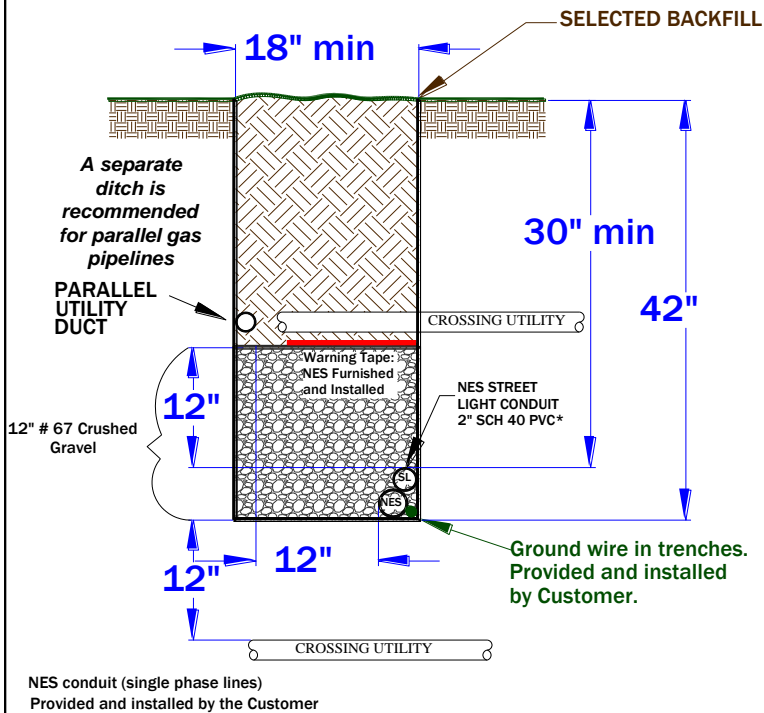

Residential Subdivision Ditch Detail For Primary Lines (1) 4", (1) 3" or (2 to 3) 2-1/2" diameter conduits" Schedule 40 PVC 2 or 3 Phase Primary

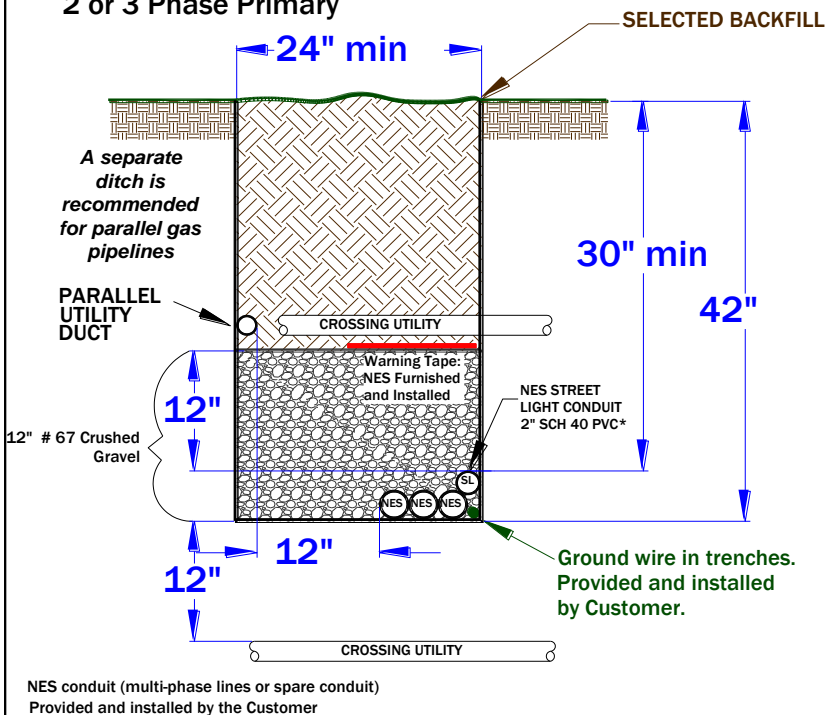

Drawing Notes:

1. The Customer is responsible for providing all conduits, elbows and appurtenances (including Manholes and Duct Banks) necessary for their proper installation.
2. The NES construction drawing(s) will show the actual number and diameter of conduits required for the project. The NES Engineer will provide the Customer these drawings at the Pre-Construction Meeting.
3. There shall be a minimum of twelve inches (12") clearance in all directions between NES conduits and any other utility's conduits.
4. The Customer is responsible for stabilization of the soil during and after construction.
5. Refer to page 31 for detailed conduit requirements. Refer to page 43 for more specific backfilling instructions.
6. NES's street lighting conduit may be positioned anywhere above or adjacent to NES's primary cable. It can not be below NES's primary.

Figure 6: Residential Primary Trench Requirements



(UG): Install Conduit and Equipment Bases

| Conductor being pulled | Conduit Diameter | Elbow Radius <i>(unless otherwise specified at Pre-Construction meeting)</i> |
|------------------------|----------------------------------|--|
| Secondary/Service | (1) - 3" | 24" |
| Single Phase Primary | (1 or 2) - 2 ½" | 24" |
| Three Phase Primary | (3) - 2 ½" or (1) - 4", 5" or 6" | 24" OR 36" AS REQUIRED |
| Street Lights | (1) - 2" | 24" |

General Conduit Requirements

- **New developments with limited space may require (at the discretion of NES Engineering) an as-built underground conduit and pad-mounted equipment survey to be performed by the developer to ensure all electric facilities are placed in appropriate locations. This survey is to ensure Fire Protection clearances and working spaces are met prior to energizing equipment.**
- Conduit should be in a straight line run between elbows. (ONE sweeping bend of a fifteen-foot (15') minimum radius between elbows is allowed.)
- Conduit shall be laid in the trench so the print indicating the conduit size is visible.
- Do not run the conduit under any permanent structure such as a building, condenser, etc.
- The conduit should be encased in concrete where it crosses under drainage ditches or small creeks. This will be discussed at the Pre-Construction Meeting.
- Conduit shall have at least five feet (5') of horizontal clearance from swimming pool enclosures.

Conduit requirements at the riser pole

- One ten-foot (10') length of conduit up the pole from the elbow shall be rigid galvanized steel.
- A 24" or 36" radius rigid galvanized elbow is required.
- Cap the end of the riser pole conduit(s).
- There shall be a seven and one-half inch (7 ½") space between pole and conduit.

Secondary Riser pole to meter base (page 33 and 34) or riser pole to pull box, (page 35)

- The conduit shall be a minimum schedule 40 PVC. (special circumstances may warrant the use of concrete encasement or rigid galvanized steel).
- Rigid galvanized steel is required for the elbow at the meter base.
- Schedule 80 PVC or rigid galvanized steel is required up to meter base.
- For services greater than 400 amps, install a second conduit run as a spare for additional conductor that may be needed for repairs, or if service is upgraded. The spare conduit should be capped on the riser. Spare conduit should include pull tape (Neptco Muletape WP250P or equivalent). The pull tape should be glued to the conduit cap.



Electric Service Guidelines

Primary Riser pole to pad-mounted transformer (page 36)

- The first ten-foot length out of the riser elbow, and last ten-foot (10') length before the pad-mounted transformer elbow, shall be rigid galvanized steel.
- The elbow at the pad-mounted transformer shall be rigid galvanized steel.
- Stop ditch 10' short of riser pole stake until pole is set.
- Install the fiberglass pad for mounting the transformer (page 37), and any additional equipment bases (pages 104 through 107).
- Neptco "Muletape" catalog number WP1250P or equivalent 1/2" pull tape shall be installed in both **primary and secondary** conduits. The tape's breaking strength shall be at least 1250 lb.
- If crossing under a drainage ditch or small creek, include a concrete encasement as discussed at the Pre-Construction Meeting.
- There shall be at least five feet (5') between the conduit and the swimming pool enclosure.

Pad-mount transformer to meter base (page 38 and 39)

- The conduit from the meter to the elbow shall be schedule 80 PVC or rigid galvanized steel
- The elbows shall be rigid galvanized steel.
- Schedule 40 PVC may be allowed between elbows. (Special circumstances may warrant the use of concrete encasement or rigid galvanized steel.)
- For services greater than 400 amps see page 39.
- Metering equipment shall not be mounted on the transformer.

! If conduit must be relocated because Customer did not follow these requirements, it will be done at the Customer's expense.

DITCH INSTALLATION PROCESS

1. EXCAVATE DITCH
2. INSTALL CONDUIT
3. GO TO <https://www.nespower.com/DitchInspection.aspx> TO REQUEST INSPECTION.
4. BACKFILL 12" WITH #67 CRUSHED GRAVEL
5. GO TO <https://www.nespower.com/DitchInspection.aspx> TO REQUEST INSPECTION.
6. AFTER WARNING TAPE IS INSTALLED, BACKFILL TO FINISHED GRADE.

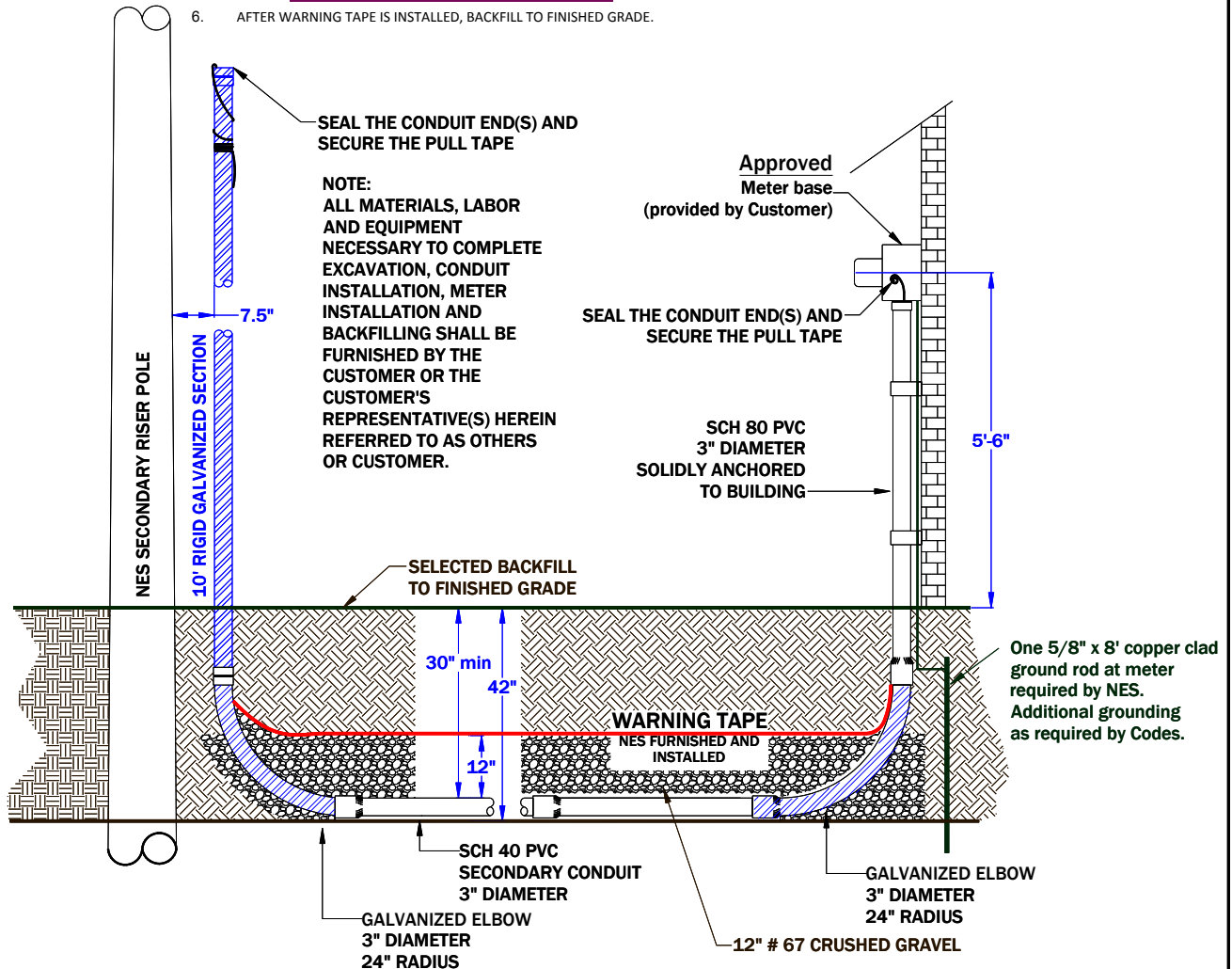

Drawing Notes:

1. Three inch (3") conduit and twenty-four inch (24") radius elbows are to be used unless otherwise specified during the Pre-Construction Meeting.
2. Ditch length limited to one hundred and eighty feet (180').
3. The conduit shall be laid so the size imprint is visible.
4. The Customer is responsible for soil stabilization during and after construction.
5. For individual residences, if NES is the only utility, and the conduit is installed such that the written schedule of the conduit is visible, the dimensions may be reduced to six inches (6") wide by thirty-six inches (36") deep, enabling Customer to use a trencher.
6. **Customer shall provide and install lugs for meter base.**
7. Conduit(s) shall have a pull string.

Figure 7: Underground Residential Service from Secondary Riser (services up to and including 400 amps)

DITCH INSTALLATION PROCESS

1. EXCAVATE DITCH
2. INSTALL CONDUIT
3. GO TO <https://www.nespower.com/DitchInspection.aspx> TO REQUEST INSPECTION.
4. BACKFILL 12" WITH #67 CRUSHED GRAVEL
5. GO TO <https://www.nespower.com/DitchInspection.aspx> TO REQUEST INSPECTION.
6. AFTER WARNING TAPE IS INSTALLED, BACKFILL TO FINISHED GRADE.

Check with local codes concerning the bonding of the neutral inside the CT Cabinet.

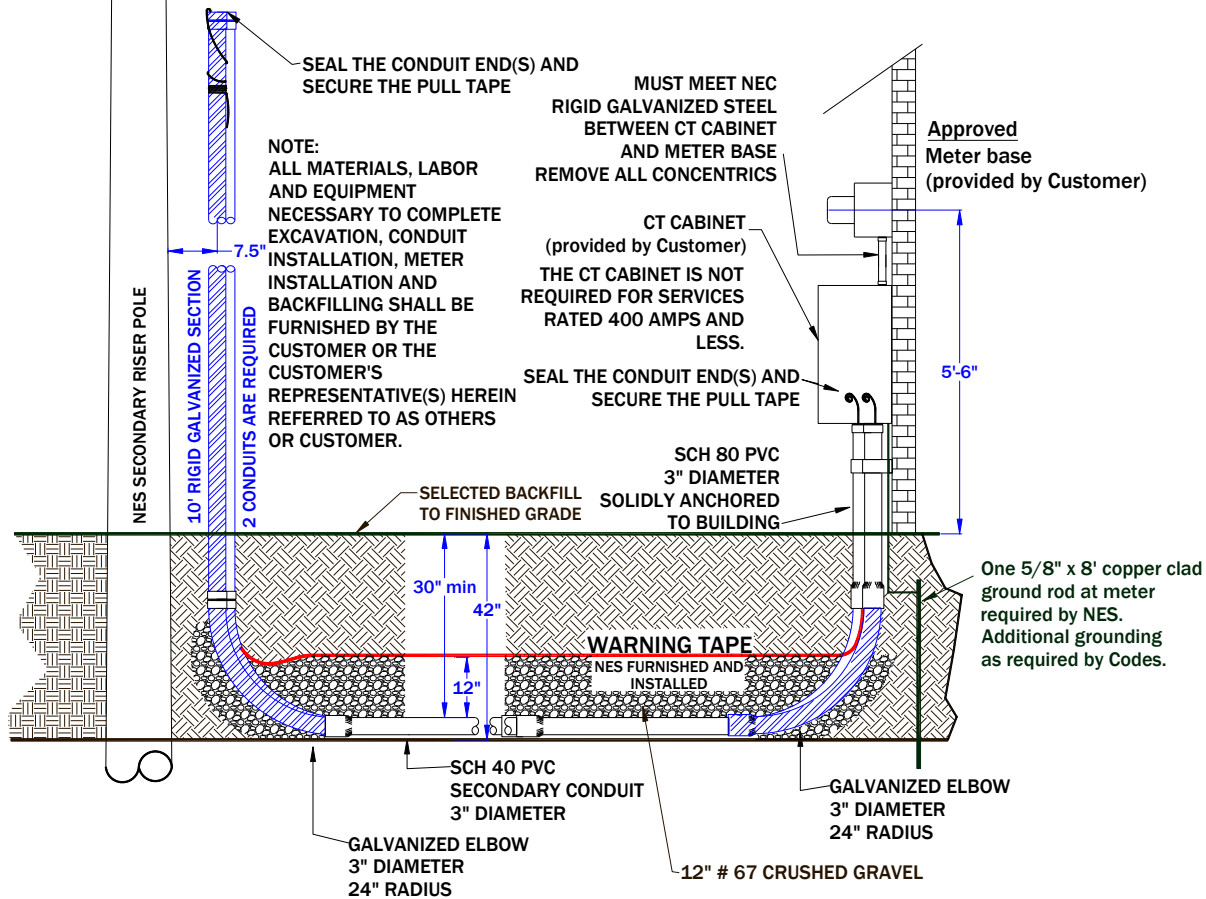
**Drawing Notes:**

1. Three inch (3") conduit and twenty-four inch (24") radius elbows are to be used unless otherwise specified during the Pre-Construction Meeting.
2. The conduit shall be laid so the size imprint is visible.
3. Contact NES Meter Department at (615) 747-3805 to pick up the current transformer (CT's).
4. The Customer is responsible for soil stabilization during and after construction.
5. For individual residences, if NES is the only utility, and the conduit is installed such that the written schedule of the conduit is visible, the dimensions may be reduced to six inches (6") wide by thirty-six inches (36") deep, enabling Customer to use a trencher.
6. Spare conduit should include pull tape. In spare conduit pull tape should be glued to the conduit cap on the riser.
7. Customer provides pull string in conduit(s).

**Figure 8: Underground Residential Service from Secondary Riser Pole
(Services greater than 400 Amp/800 Amp Maximum)**

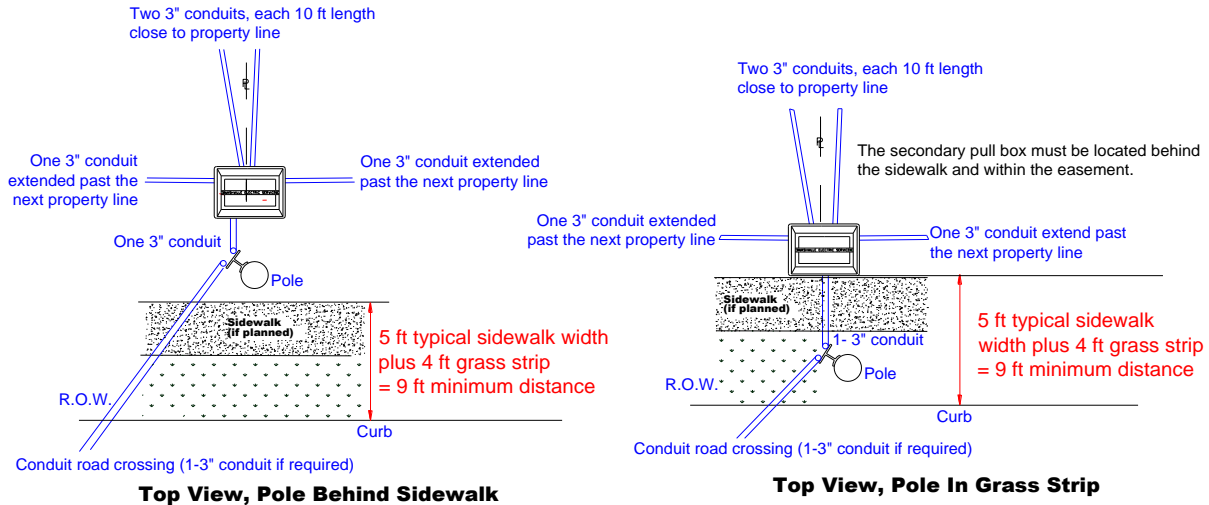

DITCH INSTALLATION PROCESS

1. EXCAVATE DITCH AND PULL BOX HOLE
2. INSTALL CONDUIT
3. GO TO <https://www.nespower.com/DitchInspection.aspx> TO REQUEST INSPECTION.
4. BACKFILL 12" WITH #67 CRUSHED GRAVEL AS REQUIRED UNDER PULLBOX AND SET PULLBOX.
5. GO TO <https://www.nespower.com/DitchInspection.aspx> TO REQUEST INSPECTION.
6. AFTER WARNING TAPE IS INSTALLED, BACKFILL TO FINISHED GRADE.

NOTE:
ALL MATERIALS, LABOR AND EQUIPMENT NECESSARY TO COMPLETE EXCAVATION, CONDUIT INSTALLATION, AND BACKFILLING SHALL BE FURNISHED BY THE CUSTOMER OR THE CUSTOMER'S REPRESENTATIVE(S) HEREIN REFERRED TO AS OTHERS OR CUSTOMER.

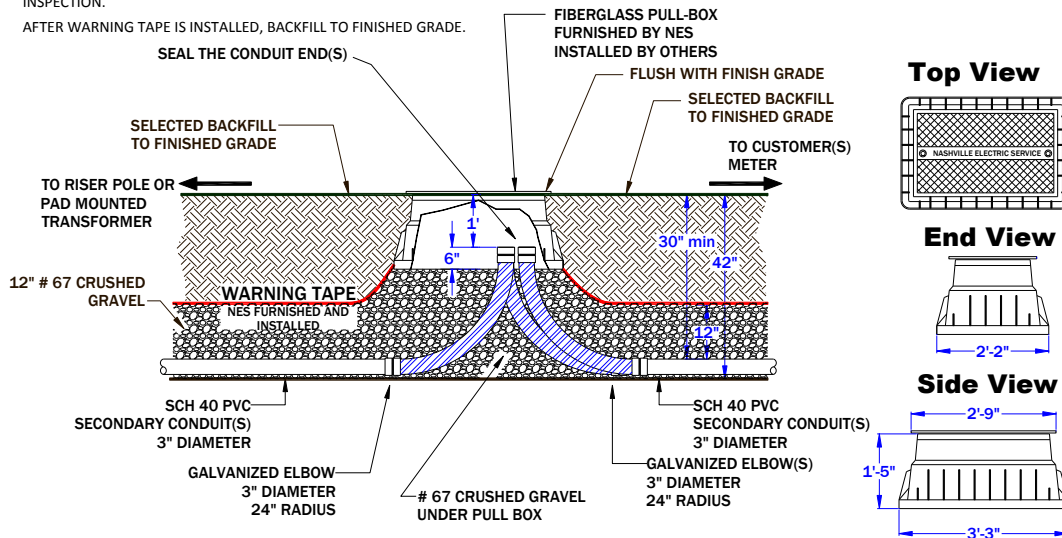

Drawing Notes:

1. Three inch (3") conduit laid with imprint visible and twenty-four inch (24") radius elbows to be used unless otherwise specified during the Pre-Construction Meeting. Maximum five conduits-one source, four feed.
2. Final grade shall be within one inch (1") of the top of the fiberglass pull box.
3. Spare conduit should include pull tape. In spare conduit pull tape should be glued to the spare conduit cap.
4. All conduit terminations shall be grouped on one end.

Figure 9: Underground Residential Service from Secondary Riser Pole to Secondary Pull Box

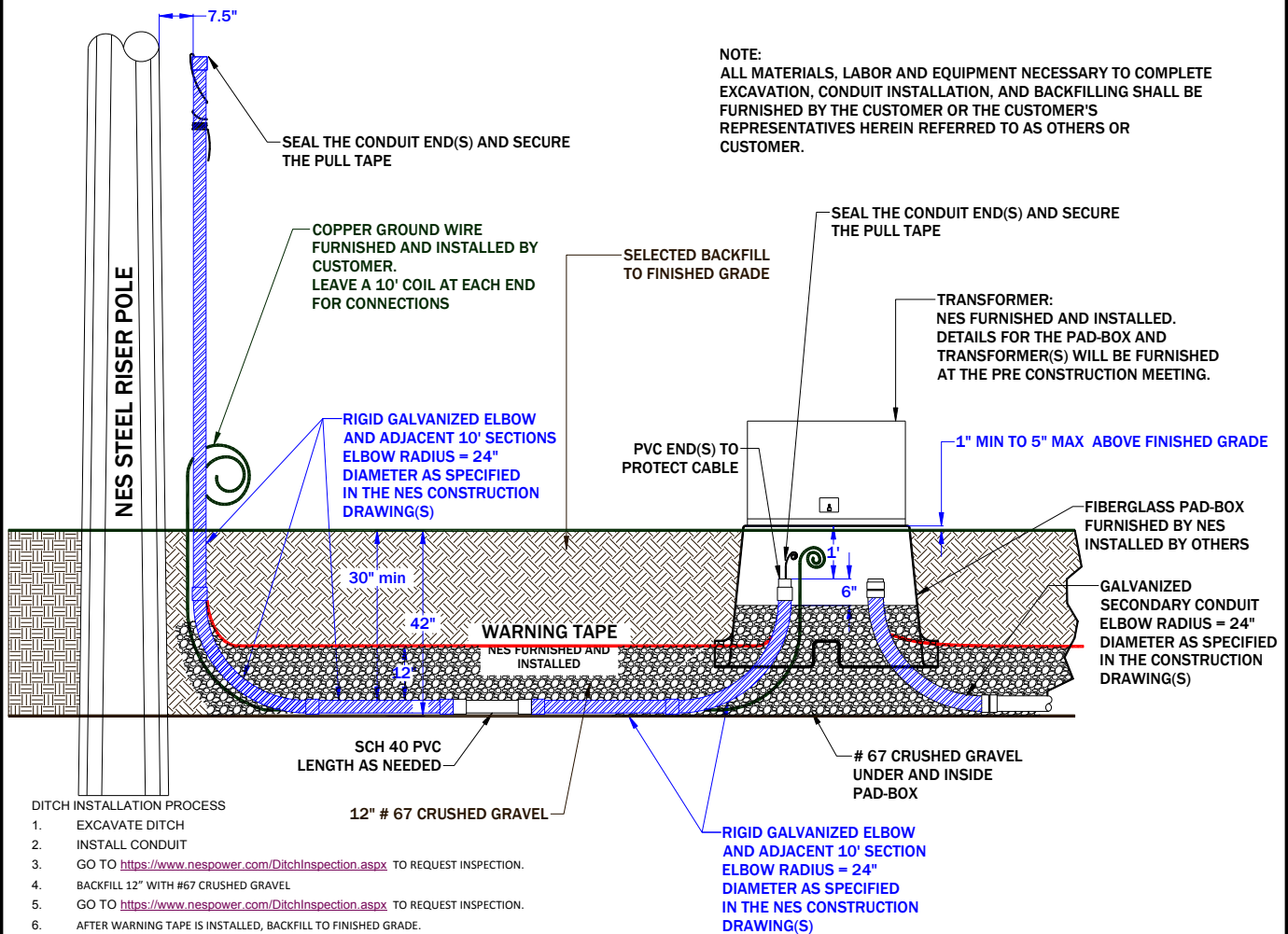

Drawing Notes:

1. Two and one-half inch (2-1/2") conduit(s) and twenty-four inch (24") radius elbows are to be used unless otherwise specified during the Pre-Construction Meeting.
2. Conduit should be laid so the size imprint is visible.
3. Coordinate with NES before installation of transformer pad box. National Fire Prevention Association regulations require oil-filled transformers be located specific distances away from buildings. Refer to Figure 51 on page 100 for more details.
4. A minimum of six feet (6') of clearance is required in front of the fiberglass transformer pad. A minimum of three feet (3') is required from the fiberglass pad on the other three sides. This includes signs, structures and the outermost branches of mature plants used for landscaping.
5. Three-phase service is considered 'commercial', even when installed on residential property. As stated in the Commercial section, the Customer is responsible for providing and installing all commercial conductors from the pad-mounted transformer to the meter base.
6. The Customer is responsible for soil stabilization during and after construction.
7. For individual residences, if NES is the only utility, and the conduit is installed such that the written schedule of the conduit is visible, the dimensions may be reduced to six inches (6") wide by thirty-six inches (36") deep, enabling Customer to use a trencher.

Top View

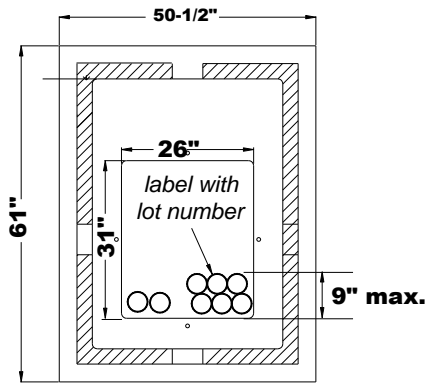

Isometric View

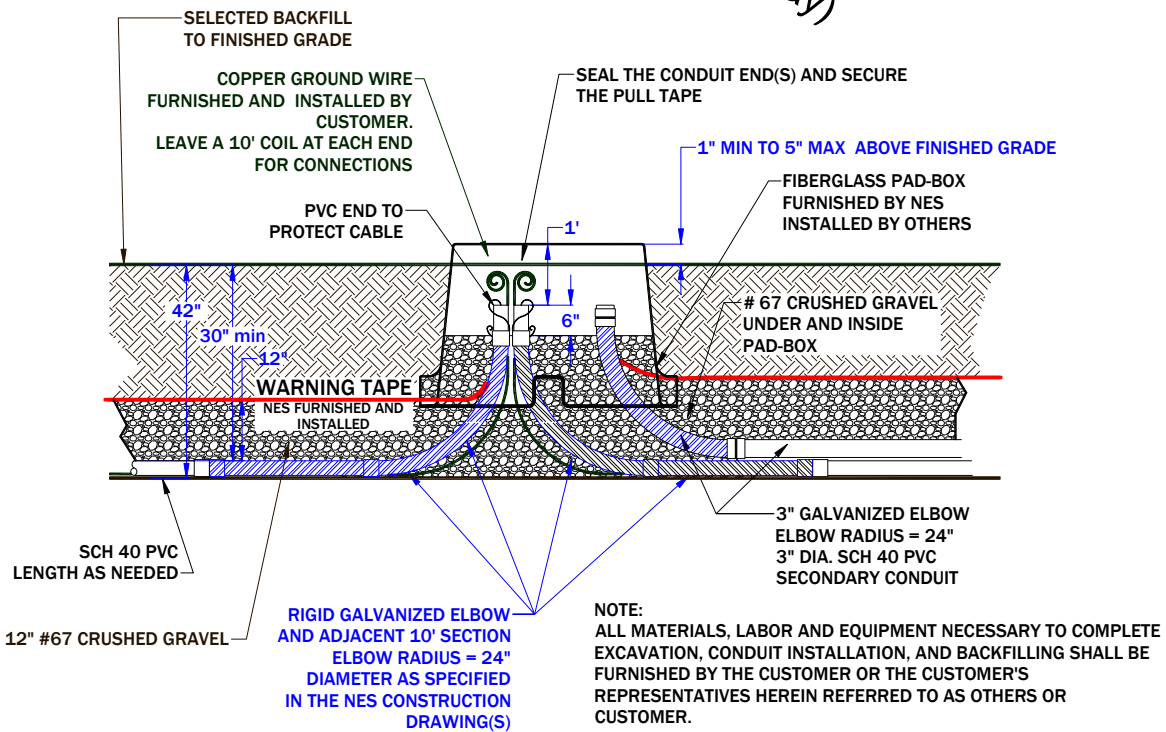
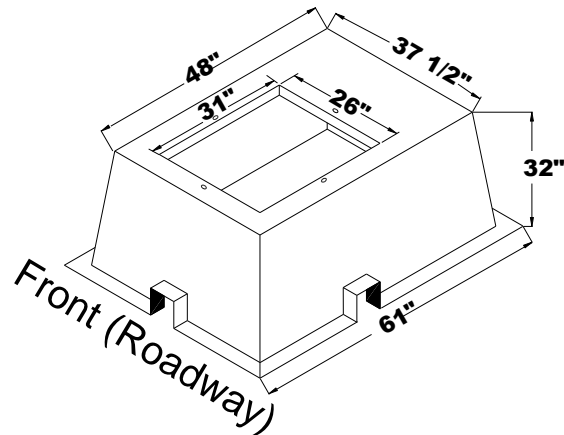

Drawing Notes:

1. Fiberglass box pad is furnished by NES however it is installed by the Customer.
2. A minimum of six feet (6') of clearance is required in front of the fiberglass transformer pad. A minimum of three feet (3') is required from the fiberglass pad on the other three sides. This includes signs, structures and the outermost branches of mature plants used for landscaping.
3. No obstructions above the pad-mounted transformer are permitted.
4. Barrier wall to be installed when distance from pad to non-fireproof building is less than allowed by National Fire Prevention Association codes (refer to Figure 51 on page 100).
5. The Customer is responsible for soil stabilization during and after construction.
6. For individual residences, if NES is the only utility, and the conduit is installed such that the written schedule of the conduit is visible, the dimensions may be reduced to six inches (6") wide by thirty-six inches (36") deep, enabling Customer to use a trencher.

Figure 11: Fiberglass Box Pad for Single Phase Transformer

DITCH INSTALLATION PROCESS

1. EXCAVATE DITCH
2. INSTALL CONDUIT
3. GO TO <https://www.nespower.com/DitchInspection.aspx> TO REQUEST INSPECTION.
4. BACKFILL 12" WITH #67 CRUSHED GRAVEL
5. GO TO <https://www.nespower.com/DitchInspection.aspx> TO REQUEST INSPECTION.
6. AFTER WARNING TAPE IS INSTALLED, BACKFILL TO FINISHED GRADE.

NOTE:

ALL MATERIALS, LABOR AND EQUIPMENT NECESSARY TO COMPLETE EXCAVATION, CONDUIT INSTALLATION, METER INSTALLATION AND BACKFILLING SHALL BE FURNISHED BY THE CUSTOMER OR THE CUSTOMER'S REPRESENTATIVE(S) HEREIN REFERRED TO AS OTHERS OR CUSTOMER.

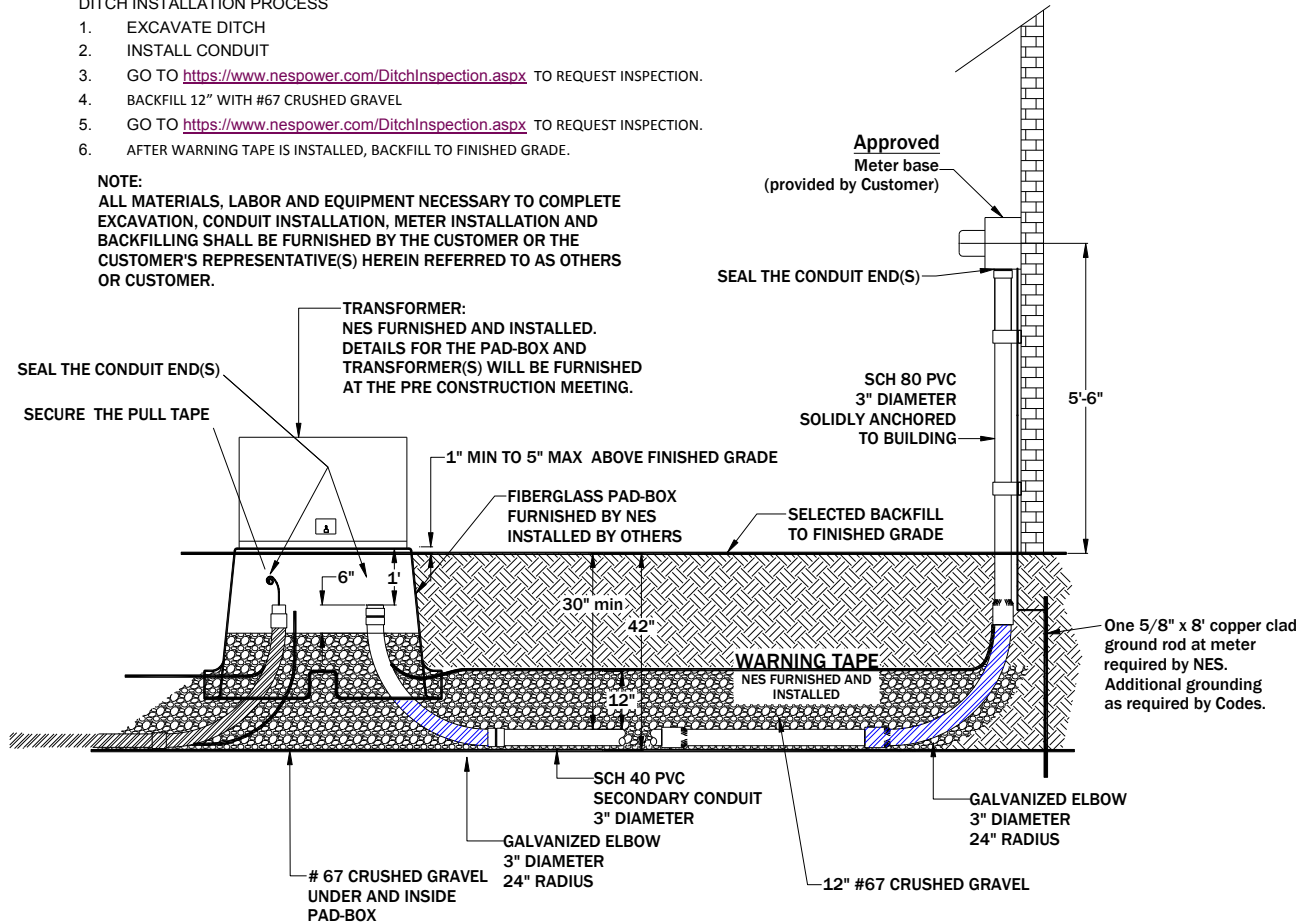
**Drawing Notes:**

1. The maximum number of secondary conduits for each pad-mounted transformer are as follows:
 - **Transformers 25-50kVA - (6) three-inch (3") Permanent Service Conduits**
 - **Transformers 75kVA and larger - (8) three-inch (3") Permanent Service Conduits**
 - **In addition to conduits listed above, all installations may include: (1) three-inch (3") Temporary Service Conduit and (1) two-inch (2") street light service conduit.**
2. A minimum of six feet (6') of clearance is required in front of the fiberglass transformer pad. A minimum of three feet (3') is required from the fiberglass pad on the other three sides. This includes signs, structures and the outermost branches of mature plants used for landscaping.
3. Barrier wall to be installed when distance from pad to non-fireproof building is less than allowed by National Fire Prevention Association codes (refer to Figure 51 on page 100).
4. The Customer is responsible for soil stabilization during and after construction.
5. For individual residences, if NES is the only utility, and the conduit is installed such that the written schedule of the conduit is visible, the dimensions may be reduced to six inches (6") wide by thirty-six inches (36") deep, enabling Customer to use a trencher.
6. See page 97, Figure 48 for specific transformer installation, knuckle boom truck clearance requirements.

Figure 12: Underground Residential Service from a Pad-mounted Transformer (services up to and including 400 amps)

DITCH INSTALLATION PROCESS

1. EXCAVATE DITCH
2. INSTALL CONDUIT
3. GO TO <https://www.nespower.com/DitchInspection.aspx> TO REQUEST INSPECTION.
4. BACKFILL 12" WITH #67 CRUSHED GRAVEL
5. GO TO <https://www.nespower.com/DitchInspection.aspx> TO REQUEST INSPECTION.
6. AFTER WARNING TAPE IS INSTALLED, BACKFILL TO FINISHED GRADE.

NOTE:

ALL MATERIALS, LABOR AND EQUIPMENT NECESSARY TO COMPLETE EXCAVATION, CONDUIT INSTALLATION, METER INSTALLATION AND BACKFILLING SHALL BE FURNISHED BY THE CUSTOMER OR THE CUSTOMER'S REPRESENTATIVE(S) HEREIN REFERRED TO AS OTHERS OR CUSTOMER.

Check with local codes concerning the bonding of the neutral inside the CT Cabinet.

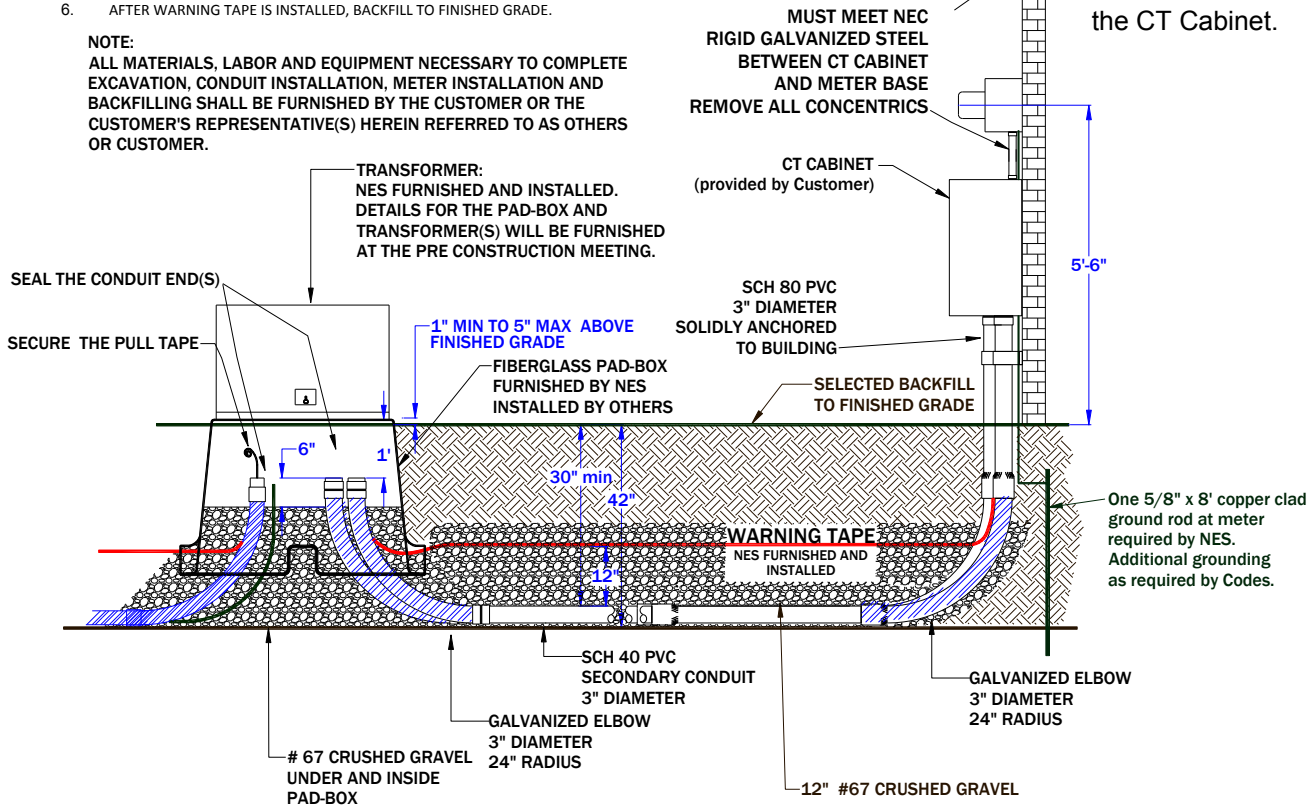

Drawing Notes:

1. The maximum number of secondary conduits for each pad-mounted transformer are as follows:
 - **Transformers 25-50kVA - (6) three-inch (3") Permanent Service Conduits**
 - **Transformers 75kVA and larger - (8) three-inch (3") Permanent Service Conduits**
 - **In addition to conduits listed above, all installations may include: (1) three-inch (3") Temporary Service Conduit and (1) two-inch (2") street light service conduit.**
2. A minimum of six feet (6') of clearance is required in front of the fiberglass transformer pad. A minimum of three feet (3') is required from the fiberglass pad on the other three sides. This includes signs, structures and the outermost branches of mature plants used for landscaping.
3. Barrier wall to be installed when distance from pad to non-fireproof building is less than allowed by National Fire Prevention Association codes (refer to Figure 51 on page 100).
4. The Customer is responsible for soil stabilization during and after construction.
5. Pull tape is also required in spare conduits. In spare conduit, pull tape should be glued to the conduit cap.
6. Check with local codes concerning the bonding of the neutral inside the CT Cabinet.
7. See page 97, Figure 48 for specific transformer installation, knuckle boom truck clearance requirements.

Figure 13: Underground Residential Service from Pad-mounted Transformer (services greater than 400 amps)

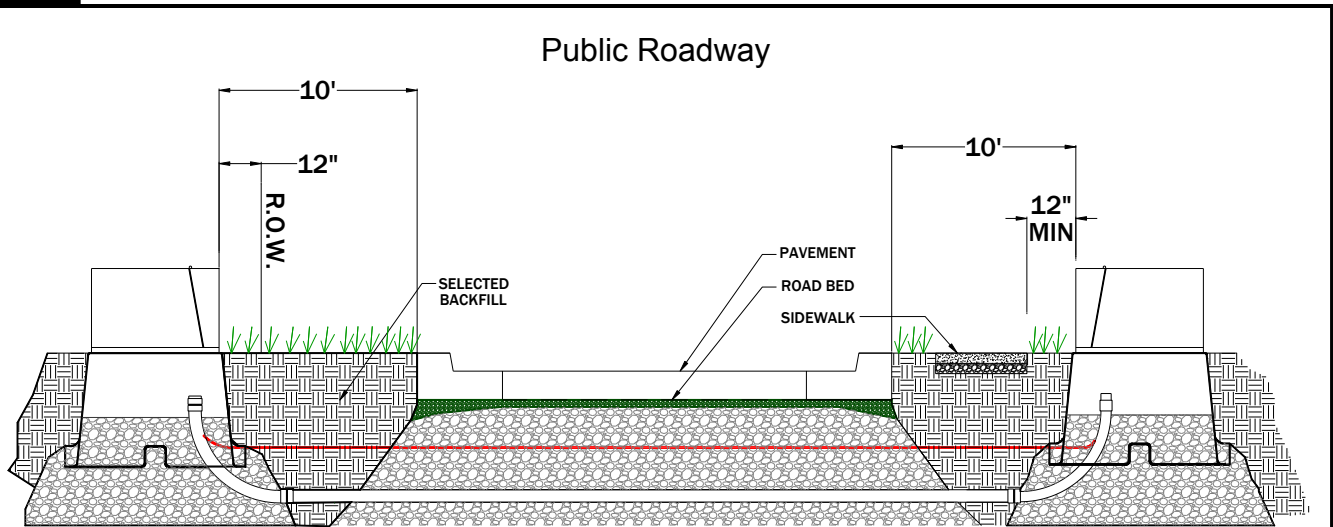
**Drawing Notes:**

1. A minimum of six feet (6') of clearance is required in front of the fiberglass transformer pad. A minimum of three feet (3') is required from the fiberglass pad on the other three sides. This includes signs, structures and the outermost branches of mature plants used for landscaping.
2. Barrier wall to be installed when distance from pad to non-fireproof building is less than allowed by National Fire Prevention Association codes (refer to Figure 51 on page 100).
3. The Customer is responsible for soil stabilization during and after construction.
4. Additional clearances may be required for limited access highway.
5. See pages 30 - 39 for specific ditch and conduit requirements.
6. See page 97, Figure 48 for specific transformer installation, knuckle boom truck clearance requirements.

Figure 14: Typical Residential Pad Mounted Equipment Set Back Requirements

TOP VIEW OF CONDUITS IN FIBERGLASS PAD

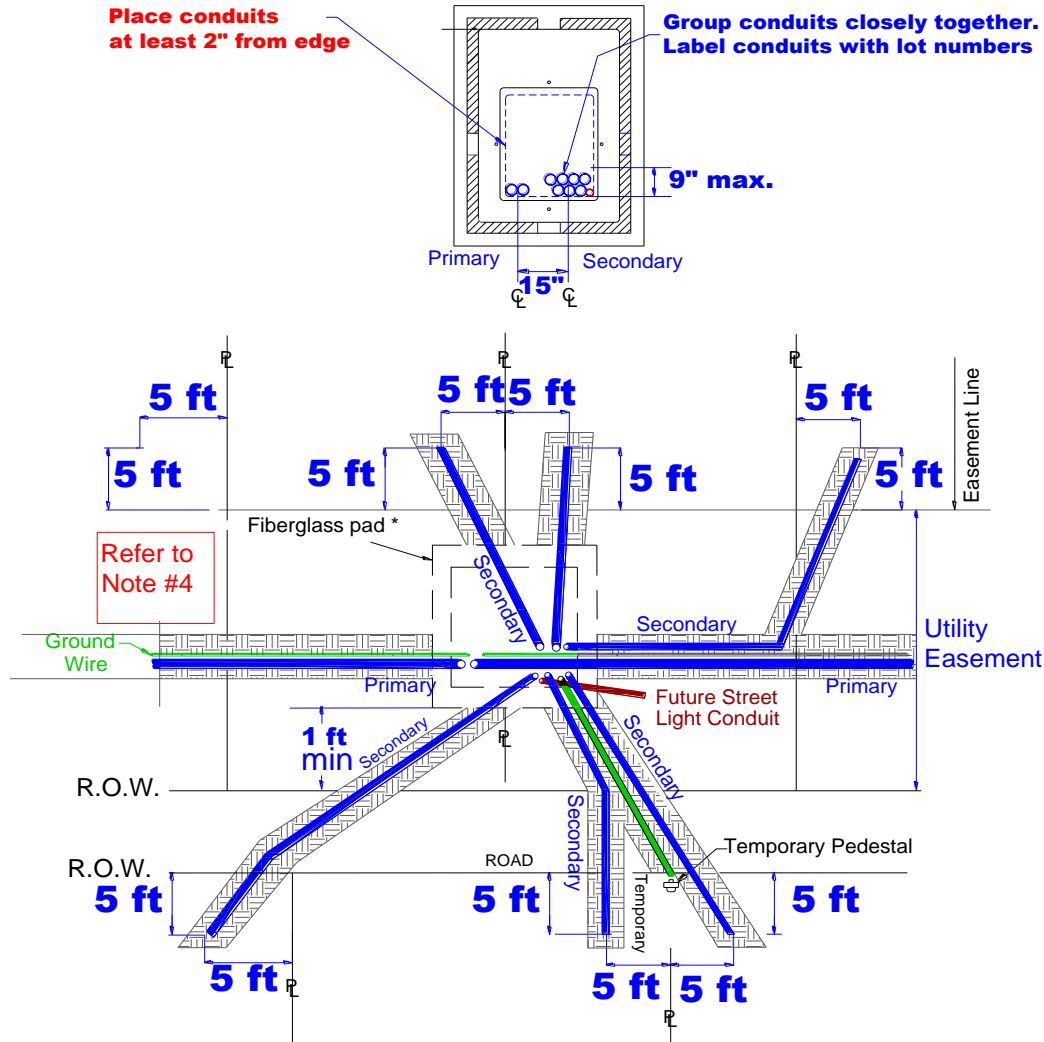

Drawing Notes:

1. Maximum number of conduits for each pad-mounted transformer are as follows:
Six (6) permanent service conduits for 25-50 kVA transformer sizes, or eight (8) permanent service conduits for 75 kVA or larger (three-inch (3") unless otherwise specified at Pre-construction Meeting) **plus** one (1) temporary service conduit (three-inch (3") unless otherwise specified) **plus** one (1) street light conduit (two-inch (2") unless otherwise specified).
2. The primary and secondary conduits shall be grouped together such that there is fifteen inches (15") between the center lines of each group.
3. All pad-mounted transformers in subdivisions will be designed to include a two-inch (2") stub-out for future roadway lighting.
4. Group conduits together as closely as possible.
5. Other utilities (telephone, cable TV) shall be located greater than six feet (6') from the fiberglass pad.
6. Conduit shall be laid in the trench so the print indicating conduit size is visible.
7. **New Developments with limited space may require (at the discretion of NES Engineering) an as-built underground conduit and pad-mounted equipment survey to be performed by the developer.**
8. See page 97, Figure 48 for specific transformer installation, knuckle boom truck clearance requirements.

Figure 15: Trenching Details for Residential Subdivisions

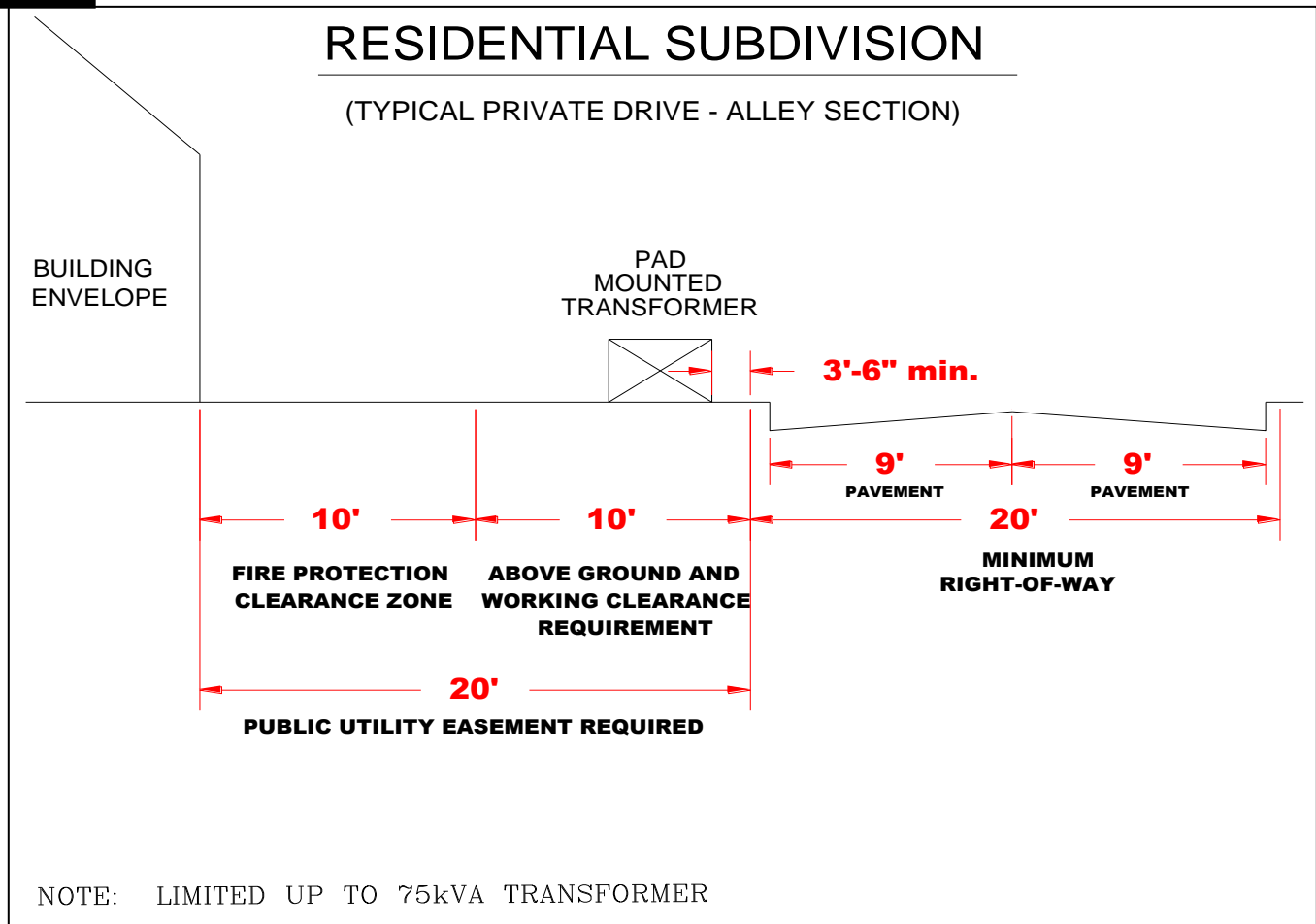

Figure 16: Private Drive and Alley Clearances

4D (UG): Arrange Inspection of Trench, Conduit and Meter Base

Contact the NES ditch inspector who will be working the job, usually the person who attended the Pre-Construction Meeting. The NES ditch inspector will inspect the job for compliance with the above requirements. The inspection shall be done before backfilling the trench. The previous steps outlined, including signing up for service, shall be completed before the ditch inspection will be done.

Note: See page 97, Figure 48 for specific transformer installation, knuckle boom truck clearance requirements.

4E (UG): Backfill Trenches

After NES approves the conduit and meter base installation, backfill the trench twelve inches (12") with #67 crushed gravel above the conduit.

Checklist for proper backfill:

- Ditch contains no solid material larger than two inches (2") in diameter.
- Ditch is free from stones, rocks, or other material which could damage the conduit.
- #67 gravel will be required twelve inches (12") above the conduit.
- The backfill under paved areas shall be #67 gravel.

4F (UG): Arrange Inspection of Backfill, Grade Property

Once the trench has been backfilled twelve inches (12”), and any changes required during the first visit have been made, contact the NES ditch inspector who did the previous inspection. The NES ditch inspector will inspect the backfill, and provide and install electrical warning tape. After this inspection, make any changes required by the NES ditch inspector. After re-inspection and warning tape installation, complete the backfilling.

4G (UG): Arrange Installation of Cables and Equipment by NES

NES will begin construction when the following are completed:

- Property, including roads, are at final grade.
- If an all-weather road was required at the Pre-Construction meeting, it shall be completed.
- All requested easements shall be recorded or an agreement to furnish and record all requested easements shall be signed by the developer.
- There shall be evidence of new home construction.
- Payment of a Contribution in Aid of Construction shall be received, if required.
- Codes release shall be received by NES before completion of job.

! Equipment relocations after installation, due to changes in final grade or other conditions, shall be at the Customer's expense.

Once these conditions are met, NES will schedule the work to install the primary and secondary conductors into the conduit, and any equipment required. NES will also provide a red stub-out marker (see Figure 58 on page 108) which will be needed to locate the conduit run once the home-owner is ready to install their service. **DO NOT REMOVE OR CUT OFF THESE MARKERS!**

The NES Meter Department will install the meter.



Electric Service Guidelines

CHAPTER IV: COMMERCIAL SERVICE

SUMMARY OF REQUIRED STEPS

| Overhead Primary and Secondary | Furnish | | Install | | More details on pgs: |
|--|----------|---------|----------|---------|----------------------|
| | Customer | Utility | Customer | Utility | |
| Set up account, place order with NES | X | | N/A | | 45 |
| Tree trimming | X | | N/A | | 47 |
| Weather-head and Meter base | X | | X | | 49, 67-69 |
| Customer-owned pedestal or pole (if required) | X | | X | | 69-70 |
| Conductor from meter base into building | X | | X | | 11,17,49 |
| Codes release to NES | X | | X | | 13,14 |
| Service conductors (transformer to meter) | | X | | X | 49 |
| Meter | | X | | X | 67, 68 |
| Overhead Primary, Underground Secondary | Furnish | | Install | | More details on pgs: |
| | Customer | Utility | Customer | Utility | |
| Set up account, place order with NES | X | | N/A | | 45 |
| Tree trimming if required | X | | X | | 47 |
| Secondary trenching and backfill | X | | X | | 51,52 |
| Meter base (location determined by NES) | X | | X | | 49, 68 |
| Customer-owned pole or pedestal (if required) | X | | X | | 69-70 |
| Secondary conduits and weather-head | X | | X | | 11,17,55 |
| Codes release to NES | X | | X | | 13,14 |
| Service conductors | | X | | X | 55 |
| Meter | | X | | X | 67-68 |
| Underground Primary and Secondary | Furnish | | Install | | More details on pgs: |
| | Customer | Utility | Customer | Utility | |
| Set up account, place order with NES | X | | N/A | | 45 |
| All trenching and backfill | X | | N/A | | 51, 52 |
| All conduits (1 and 3 phase) | X | | X | | 53, 54 |
| Concrete encasement of PVC (3 phase) | X | | X | | 56- 58 |
| Transformer pad box (1 phase) or Transformer concrete pad (3 phase) | | X | X | | 37 |
| Equipment bases (if required) | | X | X | | 104-107 |
| Equipment protection (if required) | X | | X | | 108-109 |
| Meter base (location determined by NES) | X | | X | | 67-69 |
| Primary conductors | | X | | X | 56, 63 |
| Secondary terminations and grounding in transformer | | X | | X | 56-59 |
| Current transformer (if required) | Cabinet | CT | Both | | 71-74 |
| Secondary/service conductors | X | | X | | 63 |
| Codes release to NES | X | | X | | 13,14 |
| Meter | | X | | X | 67-74 |

STEP 1: ESTABLISH ACCOUNT AND REQUEST SERVICE

If the Customer does not already have an account, call NES Energy Services at (615)747-3775 to establish one. A service charge will be billed to all new accounts except where an existing Customer was disconnected due to an NES error. Contact NES Energy Services to determine the amount of the charge.

Application for new service may be made by telephone, facsimile, mail, or in person. Identification such as driver's license, federal ID number, social security card, passport, or birth certificate is required before electric service can be provided.

Service Applications & Contracts

Contact NES Energy Services (615)747-3775 to apply for service.

A formal contract may be required for any commercial service at the discretion of the Energy Services Account Manager. All services over 50 kW demand will require a contract. A sample Contract for Electric Service is shown on page 113. The initial term of the contract depends on the demand.

! Estimate load as closely as possible. NES Customer Engineering will use this estimate to determine wire and equipment size. If the load is underestimated, the Customer can experience voltage drop or other problems.

Charges

If the new service does not generate enough annual revenue to cover annual expenses, NES requires a "Contribution in Aid to Construction" (CIAC). Other options may be available, such as an Additional Facilities Allowance. The NES Energy Services Account Manager will calculate the CIAC based on estimates made by NES, and from load information furnished on the Application for New Commercial Service.

C

Electric Service Guidelines

Deposits

NES offers a flexible, customer friendly deposit policy for commercial and industrial customers:

- A non-transferable cash deposit or satisfactory guarantee may be required for new commercial and industrial accounts before service is supplied, unless the Customer is able to provide adequate financial information or proof of satisfactory payment history from any other utility service for a minimum of one year. The amount of the deposit or guarantee shall be equal to at least twice the average monthly bill, if known, or as estimated.
- Commercial deposits will be held for a minimum of 36 months. Deposits will automatically be applied to the account after satisfactory payment history is established or upon termination of service. Satisfactory payment shall be defined as payment within the net period.
- An Irrevocable Letter of Credit may be posted by any commercial customer for a minimum of three years in lieu of a cash deposit. A local bank shall execute this on the form supplied by NES. The amount shall be equal to the normal cash deposit. The issuing bank shall be local. The Customer name shall be the same on the letter and NES records. The letter shall cover the same address/addresses. The amount shall be equal to the normal cash deposit.
- An Indemnity Bond may be posted by any commercial customer for a minimum of three years in lieu of a cash deposit. The amount shall be equal to the normal cash deposit. This is executed and maintained the same as the Irrevocable Letter of Credit, except that the Customer executes this item through an insurance company. The minimum Indemnity Bond is \$1000. NES shall have the original, notarized form. No faxed copies will be accepted.
- Interest will be paid on all deposits held by NES if the deposit is held one year. All deposits will accrue simple interest on the principal at a rate determined on the first working day of each year. The rate will be equivalent to the one year Treasury Bill minus 175 basis points, rounded off to the nearest half percent. The interest will be credited to the Customer's account.
- Special Cases: For churches that will only be using their facility two or three days per week, the deposit is lowered to one-half the calculated deposit for that square footage. For a combination office space and warehouse, where only the office space is air conditioned, the deposit is pro-rated accordingly. If one of these special cases applies, or if there is a similar special case to be considered, discuss it with the Energy Services Account Manager.

STEP 2: DESIGN DISTRIBUTION SYSTEM

The NES Energy Services Account Manager will give the application information to NES Customer Engineering. NES Customer Engineering will design the electrical layout for the business, including the location of meter bases.

STEP 3: INSTALL METER BASE AND OTHER SERVICE EQUIPMENT

For approved meter bases refer to www.nespower.com under the Builders & Contractors tab.

The meter base shall be located so it will be accessible to NES personnel. **Get any exception to the requirements listed below in writing, including the NES employee's signature.**

Meter Base Location:

- **Shall be approved by Customer Engineering**
- Shall be located on a permanent structure that is controlled by the Customer.
- Shall be located on the side of the building that is closest to normal public access.
- Cannot be mounted in exit stair breezeways (per Metro Fire Marshall).
- Shall only be surface mounted (flush-mounted or recessed meter installations are not acceptable).
- Shall not be located in an area that is subject to being fenced, such as patios, decks, porches, backyards.
- Should not be located in areas which are susceptible to subsequent enclosure by walls or screens.
- Overhead service should be located to prevent service wire from crossing a driveway if possible. If it has to cross, the point of attachment should be high enough for the lowest point of the line to be at least sixteen feet (16') above the driveway. (See page 91, Figure 42: Vertical Clearances in the Appendix for more details).
- Underground service shall be located so the conductor does not go under any permanent fixture or building, and is in a straight line. (One sweeping bend with a minimum radius of fifteen feet (15') is allowed by NES).

The reasons for these requirements are:

- Meter readers can read the meter in a cost effective manner.
- NES can efficiently maintain the meter.
- NES can quickly disconnect electrical service if there is a fire or other disaster.
- Overhead service lines crossing driveways can be hit by vehicles.
- Underground service lines can be damaged when pulling through multiple bends.

STEP 4(OH): SITE PREPARATION FOR OVERHEAD SERVICE

4A (OH): Prepare Path from the existing NES Pole to the Customer's Service Mast

The Customer is responsible for trimming and/or removing any tree growing within fifteen-feet (15') of the centerline of the primary power line, and any limbs growing within three foot (3') of the service or secondary power lines. NES will monitor Customer's vegetation growth and when necessary obtain additional clearances.

C**Electric Service Guidelines****4B (OH): Install Service Mast**

Checklist for proper installation (Refer to page 49):

- When determining the height of the weatherhead, keep in mind that service conductor can have final sag of up to five feet (5'). A Clearance section is provided on pages 91 through 99 of the appendix to help the Customer understand some of the factors NES Engineers must consider when designing an electrical layout. The Clearance section may also assist development designers in locating sidewalks, swimming pools, fire hydrants, etc.
- Contact the local Codes Inspector with questions (page 14).
- Service mast shall meet all NEC and local Codes. Check with local Codes Inspector for complete list of Codes requirements.

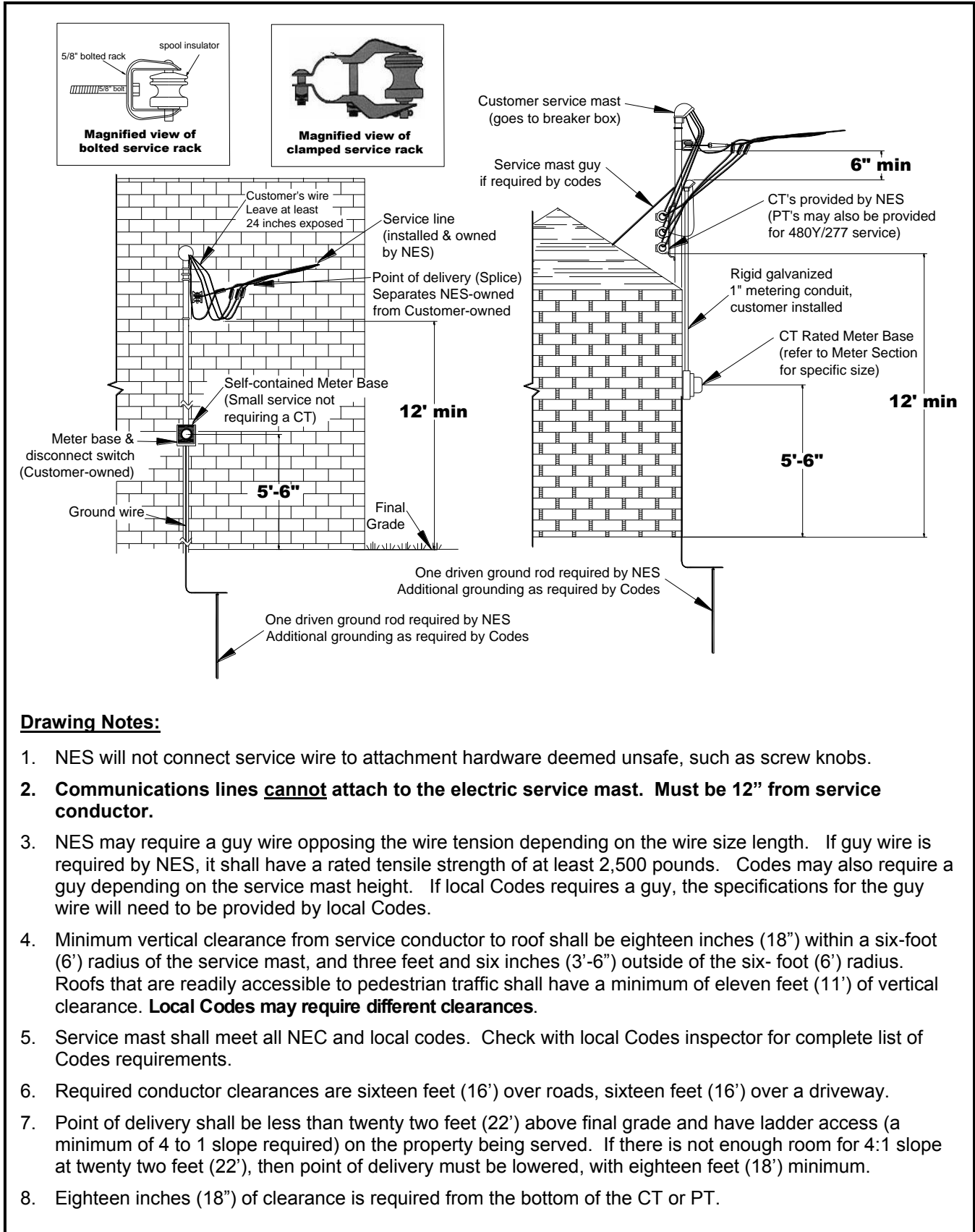

Drawing Notes:

1. NES will not connect service wire to attachment hardware deemed unsafe, such as screw knobs.
2. **Communications lines cannot attach to the electric service mast. Must be 12" from service conductor.**
3. NES may require a guy wire opposing the wire tension depending on the wire size length. If guy wire is required by NES, it shall have a rated tensile strength of at least 2,500 pounds. Codes may also require a guy depending on the service mast height. If local Codes requires a guy, the specifications for the guy wire will need to be provided by local Codes.
4. Minimum vertical clearance from service conductor to roof shall be eighteen inches (18") within a six-foot (6') radius of the service mast, and three feet and six inches (3'-6") outside of the six-foot (6') radius. Roofs that are readily accessible to pedestrian traffic shall have a minimum of eleven feet (11') of vertical clearance. **Local Codes may require different clearances.**
5. Service mast shall meet all NEC and local codes. Check with local Codes inspector for complete list of Codes requirements.
6. Required conductor clearances are sixteen feet (16') over roads, sixteen feet (16') over a driveway.
7. Point of delivery shall be less than twenty two feet (22') above final grade and have ladder access (a minimum of 4 to 1 slope required) on the property being served. If there is not enough room for 4:1 slope at twenty two feet (22'), then point of delivery must be lowered, with eighteen feet (18') minimum.
8. Eighteen inches (18") of clearance is required from the bottom of the CT or PT.

Figure 17: Commercial Service Mast Installation



Electric Service Guidelines

STEP 4(UG): SITE PREPARATION FOR UNDERGROUND SERVICE

! Do not begin digging or construction until the Pre-Construction Meeting has been held.

4A (UG): Receive Underground Layout

Once the job has been processed the Engineer will schedule a formal “Pre-Construction Meeting” to distribute construction information, but may waive the meeting in some instances (for example, the second or third phase of a subdivision when there weren’t any miscommunications on the first phase, or underground service served from an pole-type transformer).

The purpose of a Pre-Construction Meeting is to review the requirements in this handbook with the Customer, the NES Energy Services Account Manager, and the NES Operations Supervisor. Depending on the complexity of the job other representatives involved such as NES Metering, the Customer’s electrician, general contractor or subcontractors, other utilities, etc. may be invited for coordination. The NES Engineer will have a checklist of issues called the Pre-Construction Meeting Information Sheet (See pg. 113). Any exceptions to the requirements in this handbook shall be noted on the Pre-Construction Meeting Information Sheet and initialed by the Customer and an NES employee. The Customer will receive a copy of the Pre-Construction Meeting Information Sheet at the end of the meeting, along with construction drawings.

The Customer should keep the copy of the Pre-Construction Meeting Information Sheet until the project has been completed and energized. This way any discrepancies can be easily resolved.

NES supplies fiberglass pad boxes and bases for equipment such as terminating cabinets if the job requires them. The Customer is responsible for pickup and loading of fiberglass equipment. Any materials supplied by NES that are stolen, damaged or lost, shall be replaced at the Customer’s expense.

! The NES ditch inspector will not make an inspection until they have received the layout (a drawing) from the NES Engineer. A drawing cannot be made until an order is placed. Following this sequence of steps will ensure your work is handled in a timely manner.

! Customer shall provide room for riser pole on the property that will be served. Pole shall have all proper NESC clearances from other objects on Customer’s property. Pole should be located roadside if at all possible, or an easement or all weather road shall be provided.

4B (UG): Dig Trenches

! Customer should not begin trenching until NES poles have been set. If any digging must be done prior to NES poles being set, digging should stay at least fifteen feet (15') away from NES stakes. Failure to do so may delay NES installations.

General Trench Requirements

- Utility Red Dyed concrete backfill may be required for critical duct-bank construction in commercial sites.
- Use Duct Spacers on Duct Banks that are connected to a switch and/or a manhole. (Minimum 4 spacers per 20' length of Duct run)
- Trench shall be free of large or sharp rocks and construction debris.
- Trench shall meet all Occupational Safety and Health Administration (OSHA) standards.
- Excavated materials shall be at least two feet (2') from the edge of the trench.
- Trench should be a straight and level run (ONE sweeping bend of fifteen-foot (15') minimum radius between elbows is allowed.)
- Trench shall not be located under any planned permanent structures (buildings, condensers, etc).
- There shall be at least twelve inches (12") clearance vertically and horizontally between NES and other utilities' conduits. Note: If the Customer is building in the Harpeth Valley Utility District or the Hendersonville Utility District, five feet (5') clearance is required between NES and the water/waste water utilities.
- The Customer is responsible for soil stabilization during and after construction.

Primary Trenches

- The detailed drawings will be distributed at the Pre-Construction Meeting and will show the location of the trenches.
- The embedment and/or backfill material for switch pads, pull-boxes, fiberglass box pads for terminating cabinets and transformers and conduits crossings under roads and other traffic areas is #67 gravel.
- Gravel shall be filled down to undisturbed soil and below the frost line for equipment embedment.
- Use only #67 gravel to backfill trenches where the concrete encased or rigid galvanized conduit systems cross under roads or other traffic areas
- Install ground wire, pull boxes, fiberglass pads for terminating cabinets & transformers (pull boxes and fiberglass pads will be provided by NES).
- The Customer will provide any manholes and concrete pads in accordance with NES's specifications. The NES engineer will provide the specifications during the pre-construction meeting.
- Trench dimensions are determined by the number and size of conduits. A general detail is provided in Figure 18, Page 52.
- Customer is responsible for all easements and arranging any road or private property crossings.

Secondary/Service Trenches

- Trench dimensions: see Appendix for specific ditch details.

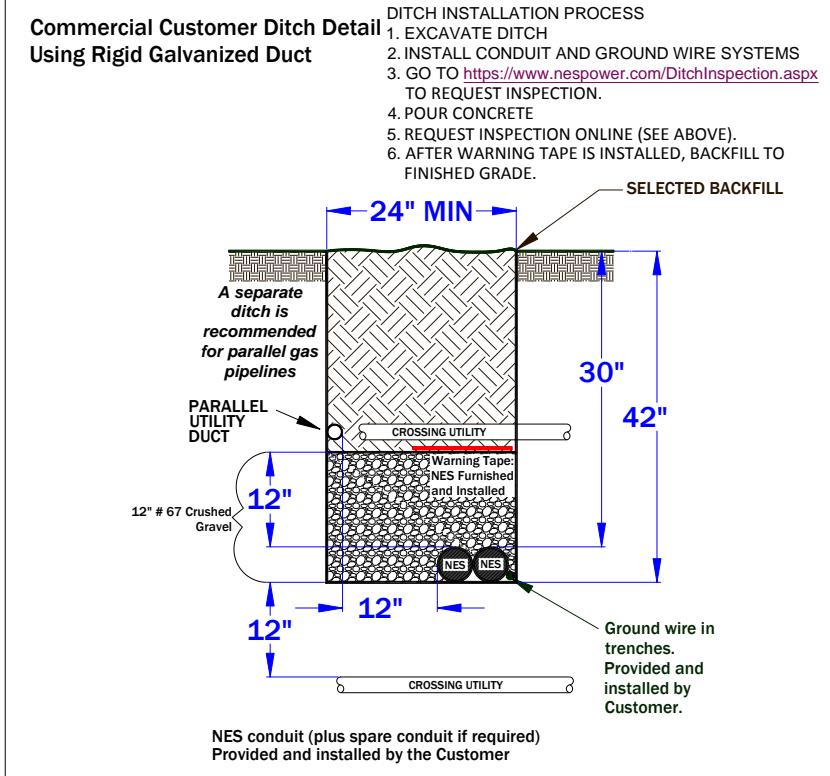
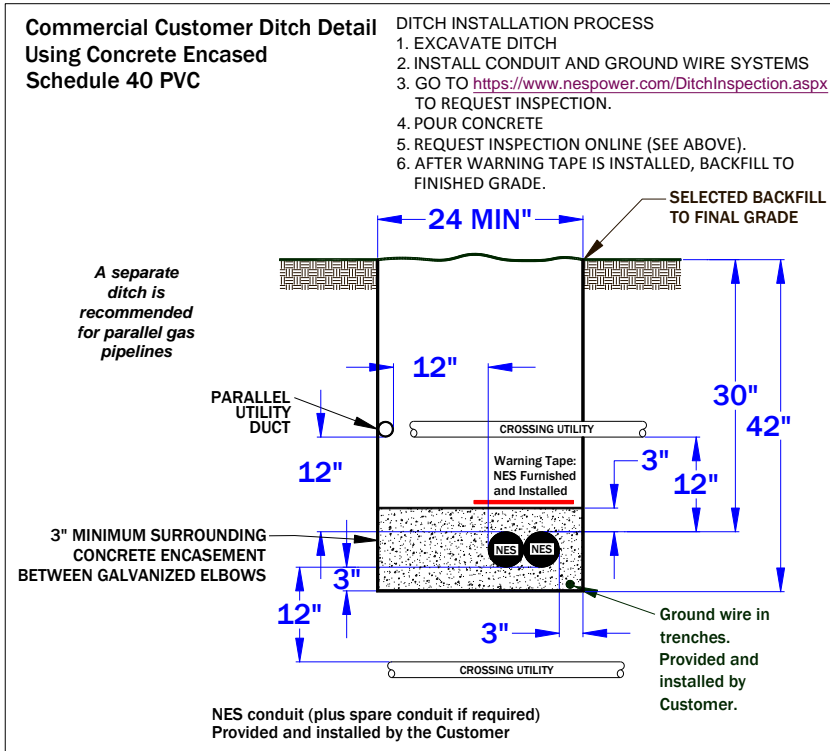

Drawing Notes:

1. A spare conduit is required to facilitate future repairs and maintenance.
2. Actual number and sizes of NES conduits and conduit fittings shall be shown on construction drawings, which shall be presented at the Pre-Construction Meeting.
3. There shall be a minimum of twelve inches (12") horizontal and vertical clearance between NES conduits and any other conduits.
4. The Customer is responsible for soil stabilization during and after construction. The Customer is also responsible for the disposition of spoils from excavation.
5. The Customer is responsible for providing all conduits, elbows and appurtenances (including Manholes and Duct Banks) necessary for their proper installation.
6. Typical Pole/Pad conduit requirements

| Size | Conduits |
|------------|----------|
| #1 | 2-4" |
| 4/0 | 2-5" |
| 500 or 750 | 2-6" |

Note: NES may require additional conduits on a case by case basis at the discretion of the NES engineer.

Utility Red Dyed concrete backfill shall be required for critical duct-bank construction in commercial sites.

Figure 18: Commercial Primary Trench Requirements

4C (UG): Install Conduit, Pads and Equipment**General Conduit Requirements**

- **New developments with limited space may require (at the discretion of NES Engineering) an as-built underground conduit and pad-mounted equipment survey to be performed by the developer to ensure all electric facilities are placed in appropriate locations. This survey is to ensure Fire Protection clearances and working spaces are met prior to energizing equipment.**
- Any PVC conduit installed shall have a minimum three inches (3") thick surrounding concrete encasement.
- Conduit should be a straight and level run (ONE sweeping bend of fifteen-foot (15') minimum radius between elbows is allowed).
- Do not run conduit under permanent structure such as building, condenser, etc.
- If rigid galvanized steel conduit crosses under a drainage ditch or small creek, include a concrete encasement as discussed at Pre-Construction Meeting.
- Conduit should be laid in the trench so the print indicating conduit size is visible.
- Conduit size will be discussed at the Pre-Construction Meeting. Size will depend on service size and length.
- There shall be at least five feet (5') of horizontal clearance from swimming pool enclosures.
- Underground services over 800 Amps shall be served with a pad-mounted transformer. They cannot be served directly from a secondary riser pole to the meter base.

Primary and secondary conduit(s) requirements at the riser pole

- One ten-foot (10') length of conduit up the pole from the elbow shall be rigid galvanized steel.
- A twenty-four-inch (24") radius elbow (rigid galvanized) is required for four inch (4") and five inch (5") conduit. Six inch (6") conduit requires a thirty-six inch (36") radius elbow. Larger radius elbows could be required by NES Operations or Engineering based on conditions encountered on the job.
- Cap both ends of the spare conduits. All conduits require a pull tape.
- There shall be seven and one-half inches (7 ½") of space between pole and conduit.



Electric Service Guidelines

Secondary conduit(s) from riser pole to meter base, up to 800 Amps (page 55)

- NES will provide and install the secondary conductors from the secondary riser to the service point.
- Rigid galvanized conduit(s) is required from riser elbow(s).
- One or two elbows, rigid galvanized steel, are required at the meter base.
- Schedule 80 PVC is required up to the meter base.

Primary conduit(s) from riser pole to pad-mounted transformer (single phase, page 56 & 57; three phase, page 58)

- First ten-foot (10') length out of riser elbow shall be rigid galvanized steel. Remainder of run may be either rigid galvanized steel or concrete encased schedule 40 PVC conduit.
- Elbows shall be twenty-four-inch (24") radius elbow(s), unless otherwise specified by Customer Engineering: Rigid galvanized steel at the pad-mounted transformer.
- Install the concrete pad or fiberglass box-pad for mounting transformer (detailed pad sketch provided at Pre-Construction Meeting).
- Neptco "Muletape" catalog number WP1250P or equivalent 1/2" pull tape shall be installed in the **primary** conduit. The tape's breaking strength shall be at least 1250 lb.
- Pulling tape in the spare conduit should be glued to the conduit cap.

Pad-mounted transformer to meter base

Customer provides, installs and owns all secondary conductor and conduit from the building to the pad mounted transformer. NES will terminate secondary conductors at the transformer. Secondary conduit quantity restrictions will be discussed at the pre-construction meeting.

Manholes, Duct Banks, Transformer & Switch Pads

Manholes are integral components to the conduit system. The customer shall provide manholes, duct banks, transformer pads, and switch pads as required. Pre-cast manholes, transformer and switch pads shall be purchased from only pre-approved manufacturers. **The specification and details will be provided by the NES engineer assigned to the job. The shop drawings for manholes and switch pads must be approved by the designing engineer.**

DITCH INSTALLATION PROCESS

1. EXCAVATE DITCH
2. INSTALL CONDUIT
3. GO TO <https://www.nespower.com/DitchInspection.aspx> TO REQUEST INSPECTION.
4. FILL WITH CONCRETE.
5. GO TO <https://www.nespower.com/DitchInspection.aspx> TO REQUEST INSPECTION.
6. AFTER WARNING TAPE IS INSTALLED, BACKFILL TO FINISHED GRADE.

Check with local codes concerning the bonding of the neutral inside the CT Cabinet.

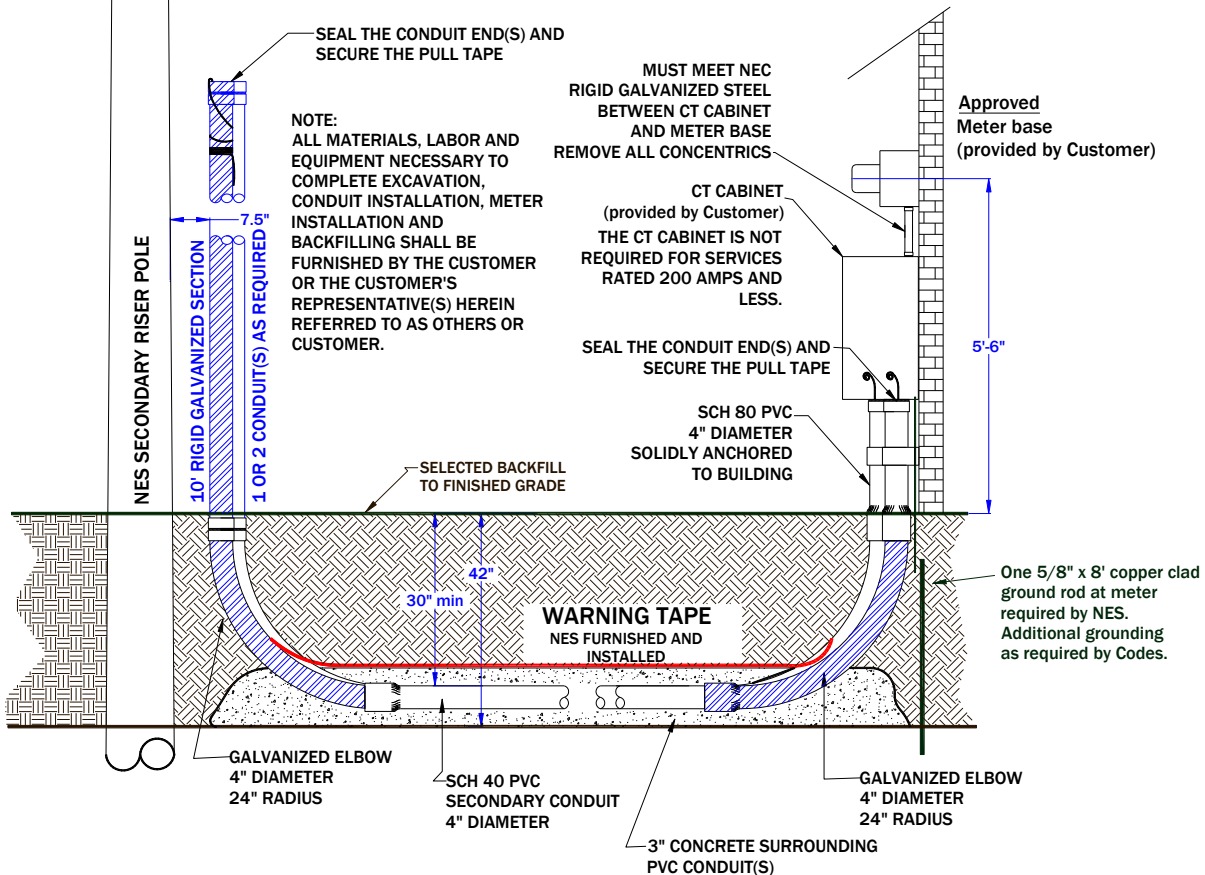

Drawing Notes:

1. Typical conduit sizes, unless otherwise specified:
Three-inch (3") conduit for single phase services.
Four-inch (4") conduit for three phase services.
Two-inch (2") conduit for services 100 Amps and less.
2. A spare conduit is required for services 600A and greater, and may be required at the Engineer's discretion for other services to facilitate future repairs and maintenance. Spare conduits shall be capped.
3. If current transformers (CT's) are required, contact NES Meter Department at (615)747-3805.
4. The Customer is responsible for soil stabilization during and after construction.
5. Conduit(s) shall have a pull string.
6. Check with local codes concerning the bonding of the neutral inside the CT Cabinet.

Figure 19: Underground Commercial Service from Secondary Riser Pole (Services greater than 100 Amp/800 Amp Maximum)

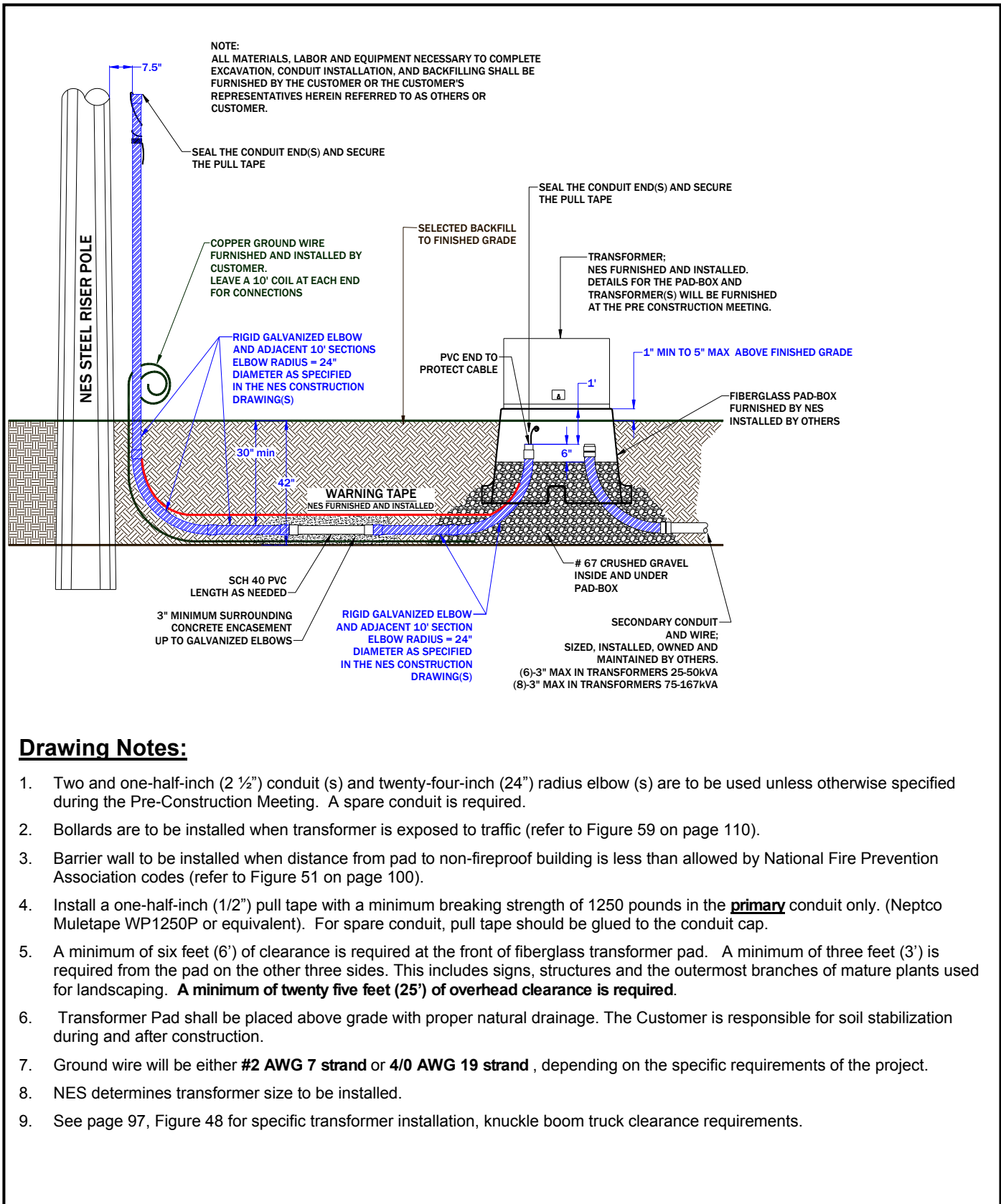

Drawing Notes:

- Two and one-half-inch (2 ½") conduit (s) and twenty-four-inch (24") radius elbow (s) are to be used unless otherwise specified during the Pre-Construction Meeting. A spare conduit is required.
- Bollards are to be installed when transformer is exposed to traffic (refer to Figure 59 on page 110).
- Barrier wall to be installed when distance from pad to non-fireproof building is less than allowed by National Fire Prevention Association codes (refer to Figure 51 on page 100).
- Install a one-half-inch (1/2") pull tape with a minimum breaking strength of 1250 pounds in the **primary** conduit only. (Neptco Muletape WP1250P or equivalent). For spare conduit, pull tape should be glued to the conduit cap.
- A minimum of six feet (6') of clearance is required at the front of fiberglass transformer pad. A minimum of three feet (3') is required from the pad on the other three sides. This includes signs, structures and the outermost branches of mature plants used for landscaping. **A minimum of twenty five feet (25') of overhead clearance is required.**
- Transformer Pad shall be placed above grade with proper natural drainage. The Customer is responsible for soil stabilization during and after construction.
- Ground wire will be either **#2 AWG 7 strand** or **4/0 AWG 19 strand**, depending on the specific requirements of the project.
- NES determines transformer size to be installed.
- See page 97, Figure 48 for specific transformer installation, knuckle boom truck clearance requirements.

Figure 20: Underground Commercial Single Phase Primary Installation (SCH 40 PVC)

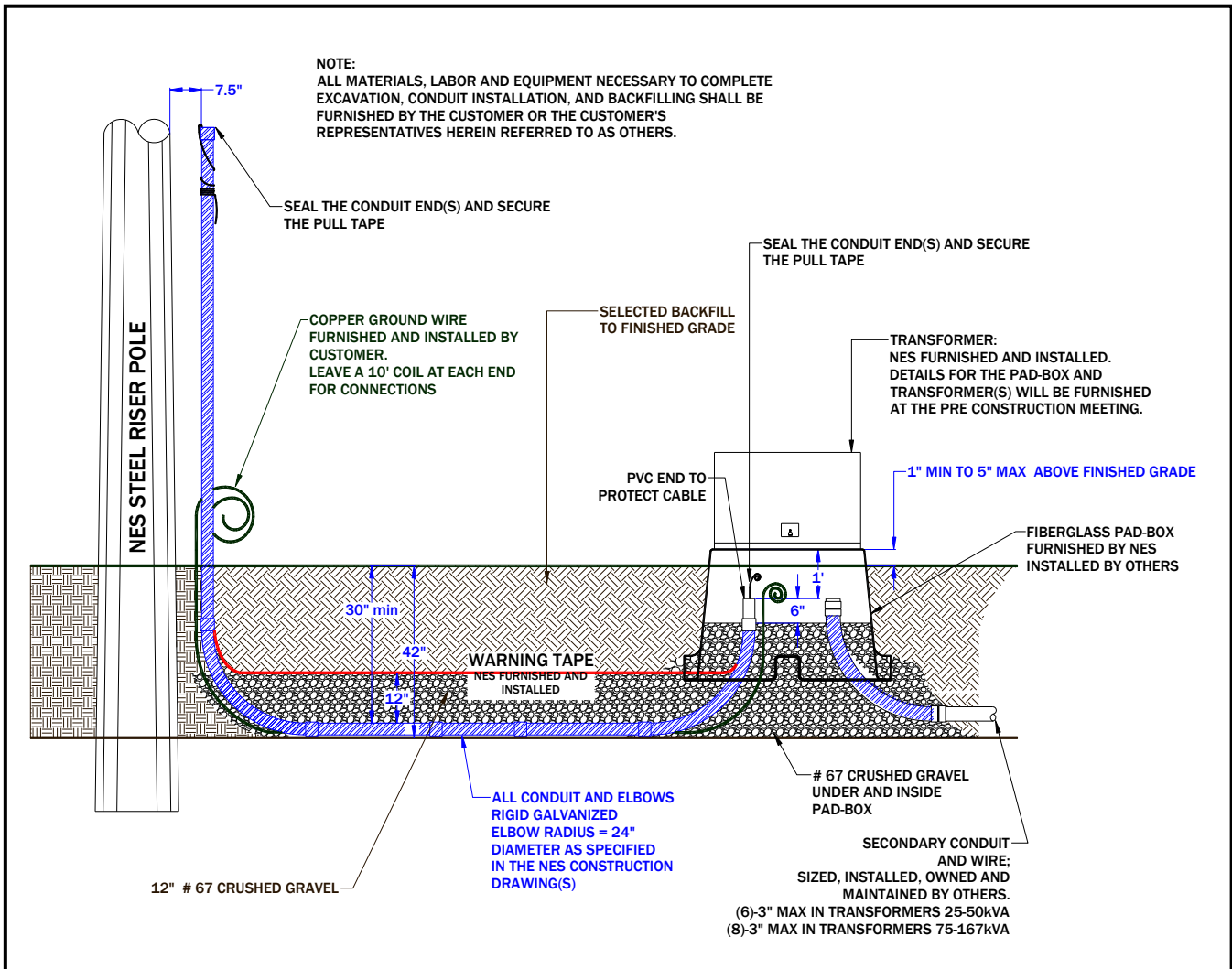

Drawing Notes:

1. Two and one-half-inch (2 1/2") conduit (s) and twenty-four-inch (24") radius elbow (s) are to be used unless otherwise specified during the Pre-Construction Meeting. A spare conduit is required.
2. Bollards are to be installed when transformer is exposed to traffic (refer to Figure 59 on page 110).
3. Barrier wall to be installed when distance from pad to non-fireproof building is less than allowed by National Fire Prevention Association Codes (refer to Figure 51 on page 100).
4. Install a one-half-inch (1/2") pull tape with a minimum breaking strength of 1250 pounds in the **primary** conduit only. (Neptco Muletape WP1250P or equivalent). In spare conduits, pull tape should be glued to the conduit cap.
5. A minimum of six feet (6') of clearance is required at the front of fiberglass transformer pad. A minimum of three feet (3') is required from the pad on the other three sides. This includes signs, structures and the outermost branches of mature plants used for landscaping. **A minimum of twenty five feet (25') of overhead clearance is required.**
6. Transformer Pad shall be placed above grade with proper natural drainage. The Customer is responsible for soil stabilization during and after construction.
7. Ground wire will be either **#2 AWG 7 strand** or **4/0 AWG 19 strand**, depending on the specific requirements of the Project.
8. NES determines transformer size to be installed.
9. See page 97, Figure 48 for specific transformer installation, knuckle boom truck clearance requirements.

Figure 21: Underground Commercial Single Phase Primary Installation (Rigid Conduit)

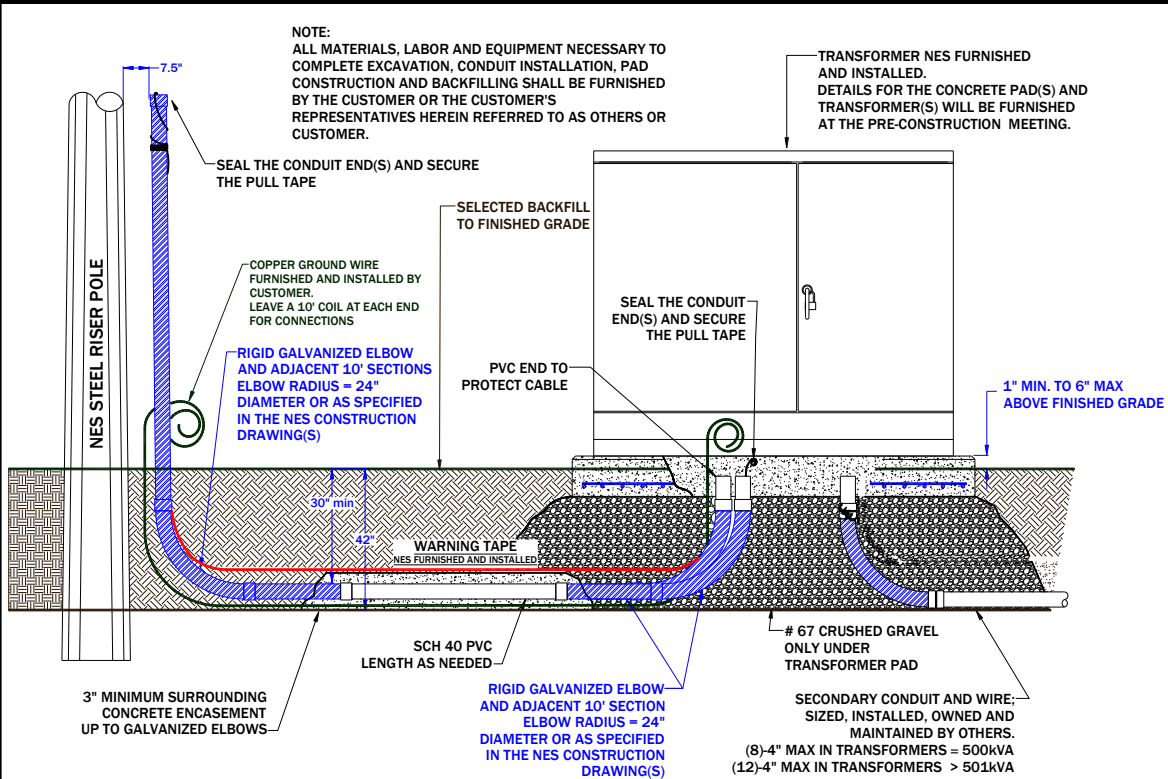

Drawing Notes:

1. Four-inch (4") conduit (s) and twenty-four-inch (24") radius elbows are to be used unless otherwise specified during the Pre-Construction Meeting. A spare conduit is required.
2. Bollards are to be installed when transformer is exposed to traffic (refer to Figure 59 on page 110).
3. NES ditch inspector shall approve form before pouring concrete pad for transformer.
4. Barrier wall to be installed when distance from pad to non-fireproof building is less than allowed by National Fire Prevention Association Codes (refer to Figure 51 on page 100).
5. Install a one-half-inch (1/2") pull tape with a minimum breaking strength of 1250 pounds in the **primary** conduit only. (Neptco Muletape WP1250P or equivalent). In spare conduits pull tape should be glued to the conduit cap.
6. A minimum of six feet (6') of clearance is required at the front of transformer pad. A minimum of three feet (3') is required from the pad on the other three sides. **A minimum of twenty five feet (25') of overhead clearance is required.** This includes signs, structures and the outermost branches of mature plants used for landscaping..
7. Transformer Pad shall be above grade with proper natural drainage. The Customer is responsible for soil stabilization during and after construction.
8. Concrete encasement is not required for galvanized conduit unless specified in the pre-construction meeting.
9. Ground wire will be either **#2 AWG 7 strand** or **4/0 AWG 7 strand** , depending on the specific requirements of the Project.
10. NES determines transformer size to be installed.
11. See page 97, Figure 48 for specific transformer installation, knuckle boom truck clearance requirements.

Figure 22: Underground Commercial Three Phase Primary Installation

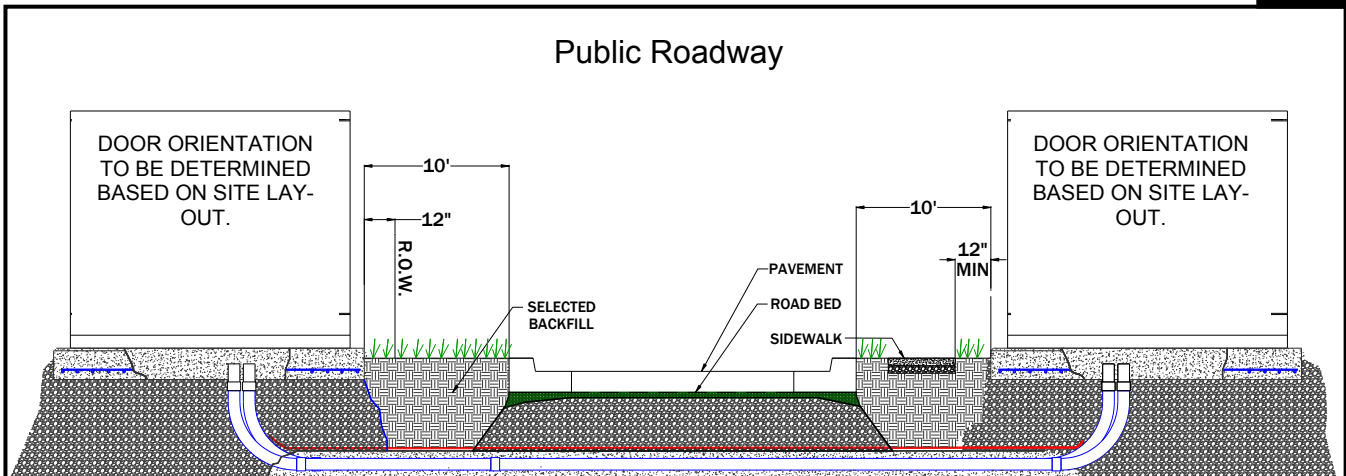

Drawing Notes:

1. A minimum of six feet (6') of clearance is required in front of the fiberglass transformer pad. A minimum of three feet (3') is required from the fiberglass pad on the other three sides. **A minimum of twenty five feet (25') of overhead clearance is required.** This includes signs, structures and the outermost branches of mature plants used for landscaping.
2. Barrier wall to be installed when distance from pad to non-fireproof building is less than allowed by National Fire Prevention Association codes (refer to Figure 51 on page 100).
3. Transformer Pad shall be above grade with proper natural drainage. The Customer is responsible for soil stabilization during and after construction.
4. Additional clearances may be required for limited access highway.
5. See pages 54 - 58 for specific ditch and conduit requirements.
6. See page 97, Figure 48 for specific transformer installation, knuckle boom truck clearance requirements.
7. Transformer must be positioned so that it doesn't have to be worked on with hot line tools from the road.

Figure 23: Typical Commercial Pad Mounted Equipment Setback Requirements

C

Electric Service Guidelines

DITCH INSTALLATION PROCESS

1. EXCAVATE DITCH
2. INSTALL CONDUIT
3. GO TO <https://www.nespower.com/DitchInspection.aspx> TO REQUEST INSPECTION.
4. BACKFILL 12" WITH #67 CRUSHED GRAVEL
5. GO TO <https://www.nespower.com/DitchInspection.aspx> TO REQUEST INSPECTION.
6. AFTER WARNING TAPE IS INSTALLED, BACKFILL TO FINISHED GRADE.

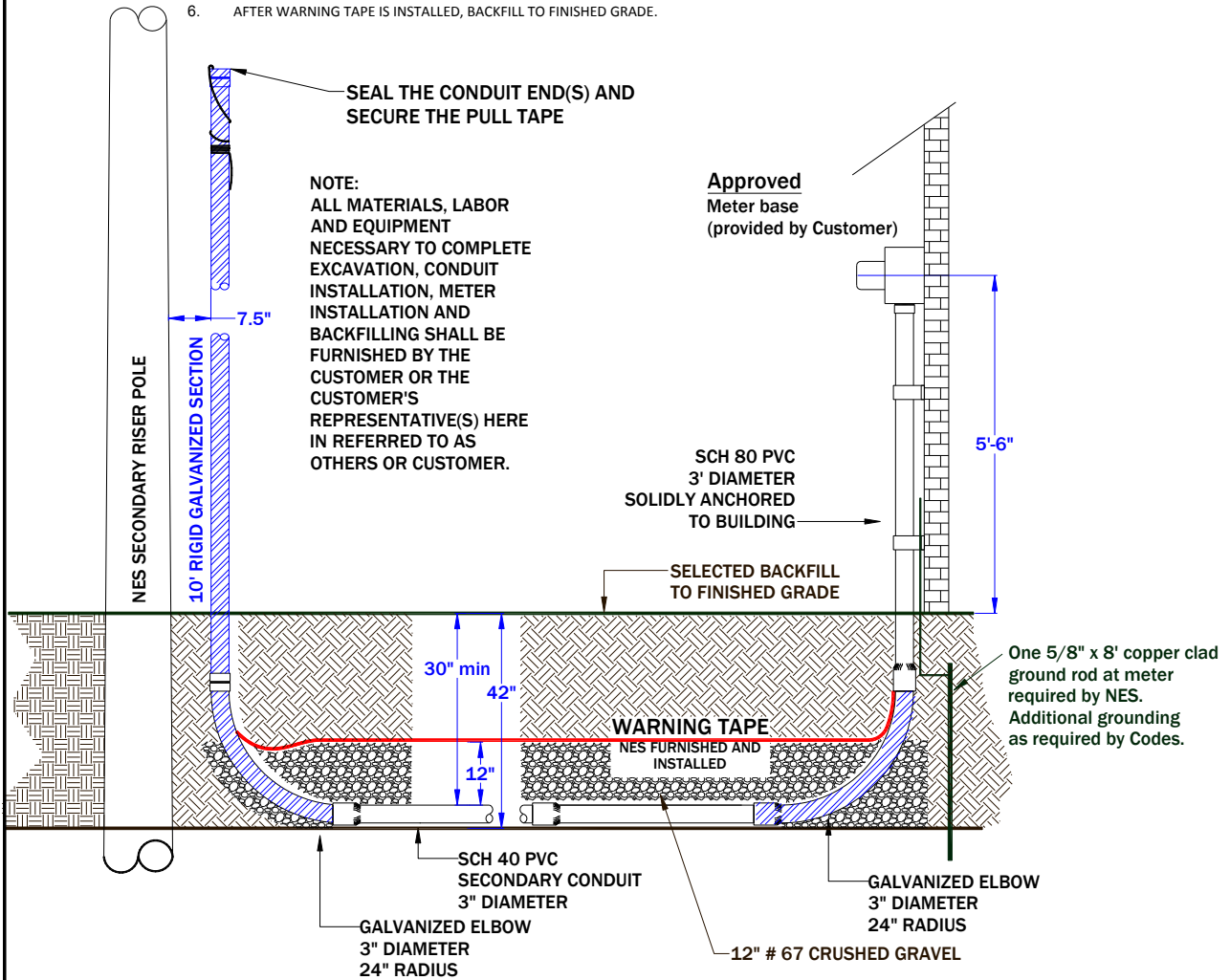

NOTE:
ALL MATERIALS, LABOR AND EQUIPMENT NECESSARY TO COMPLETE EXCAVATION, CONDUIT INSTALLATION, METER INSTALLATION AND BACKFILLING SHALL BE FURNISHED BY THE CUSTOMER OR THE CUSTOMER'S REPRESENTATIVE(S) HERE IN REFERRED TO AS OTHERS OR CUSTOMER.

Drawing Notes:

1. Three-inch (3") conduit and twenty-four-inch (24") radius elbows to be used unless otherwise specified during the Pre-Construction Meeting.
2. Conduit shall be laid so the size imprint is visible.
3. The Customer is responsible for soil stabilization during and after construction.
4. The Customer provides and installs lugs for the meter base.

Figure 24: Commercial Lighting or Supplemental Residential Service from Secondary Riser (up to and including 200 amps)

Concrete Pad Construction Notes:

1. NES will inspect all conduits prior to concrete being poured. When ready for inspection, contact the NES ditch inspector (this person's name and phone number will be supplied at the Pre-Construction Meeting).
2. **No other utilities may pass beneath the NES pad location or be located within six feet (6') of the transformer pad.**
3. NES will install grounding rods and grid at the pad location when excavation is complete and prior to backfilling or forming the pad (at the time that the rebar is inspected). Contact the NES ditch inspector.
4. Concrete shall be a minimum of 3000 PSI compressive strength at 28 days.
5. The NES pad shall be on a firm bearing. All fill material beneath the pad will be a minimum of two feet (2') of #67 washed gravel base filled to below the local frost line. Increased pad depth or concrete piers may be necessary to reach a firm bearing for the pad. Do not fill open conduit well.
6. Reinforcing steel shall be ASTM A-615 Grade 60 (#5 rebar) or better.
7. NES to inspect the pad form and rebar steel prior to concrete being poured. Contact the NES ditch inspector.
8. Bollards will be installed by Customer at NES approved locations if the NES transformer is exposed to vehicular traffic.
9. **Concrete Pad Clearances: No structure, landscaping, shrubbery or trees (final growth) allowed within six feet (6') of the front or three feet (3') from the sides and back of the concrete pad.**

! These pad sketches provide general information regarding the space and materials needed. Do NOT begin construction of the concrete pad until the Engineer determines the transformer size that will be installed and provides you a specific pad sketch for your job.

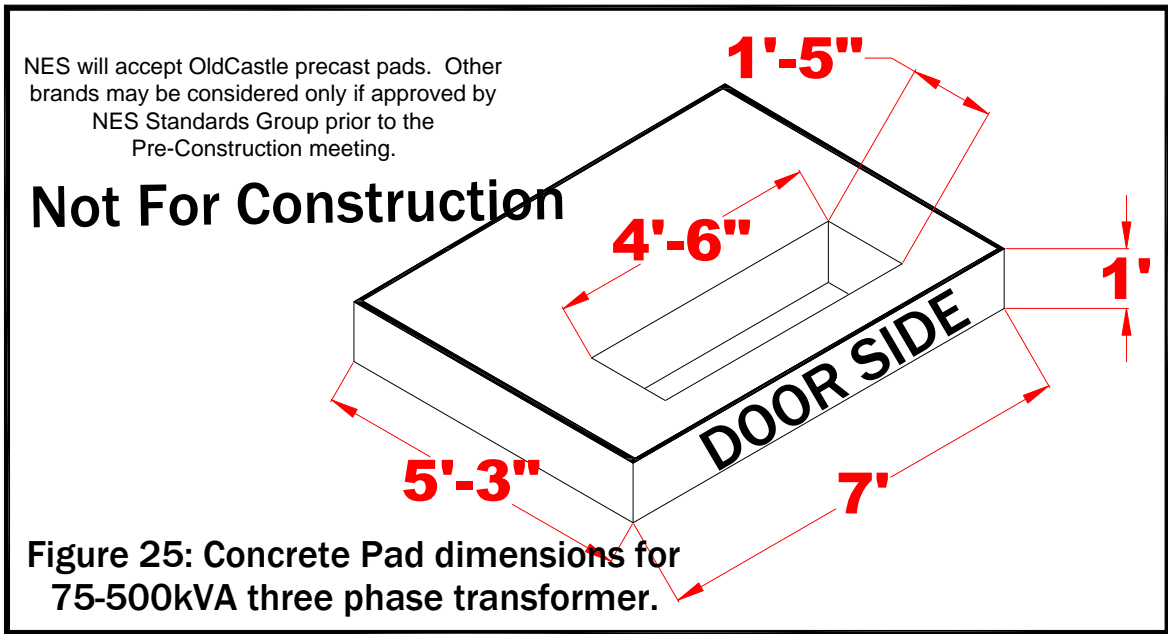

C

Electric Service Guidelines

NES will accept OldCastle precast pads. Other brands may be considered only if approved by NES Standards Group prior to the Pre-Construction meeting.

Not For Construction

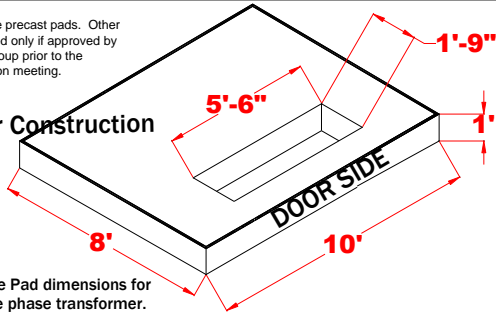

Figure 25B: Concrete Pad dimensions for 750-1500kVA three phase transformer.

NES will accept OldCastle precast pads. Other brands may be considered only if approved by NES Standards Group prior to the Pre-Construction meeting.

Not For Construction

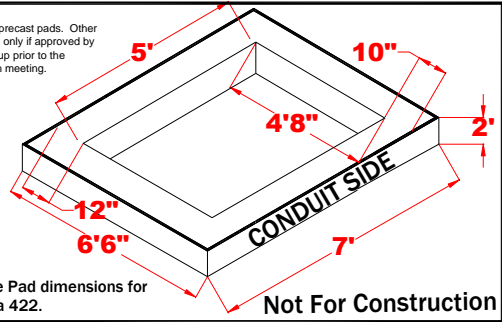

Figure 27: Concrete Pad dimensions for Vista 422.

NES will accept OldCastle precast pads. Other brands may be considered only if approved by NES Standards Group prior to the Pre-Construction meeting.

Not For Construction

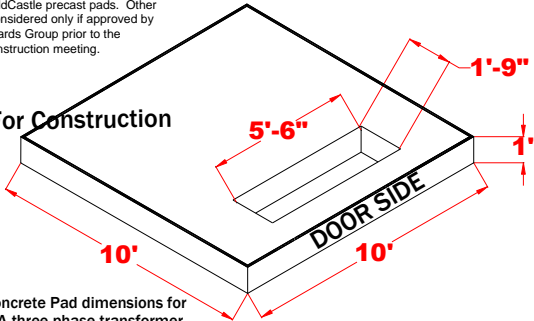

Figure 25C: Concrete Pad dimensions for 2000-5000kVA three phase transformer.

NES will accept OldCastle precast pads. Other brands may be considered only if approved by NES Standards Group prior to the Pre-Construction meeting.

Not For Construction

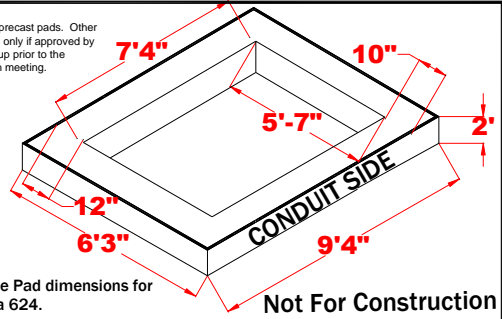

Figure 27B: Concrete Pad dimensions for Vista 624.

NES will accept OldCastle precast pads. The outside dimensions will be 8'4" by 8'4". Other brands may be considered only if approved by NES Standards Group prior to the Pre-Construction meeting.

Not For Construction

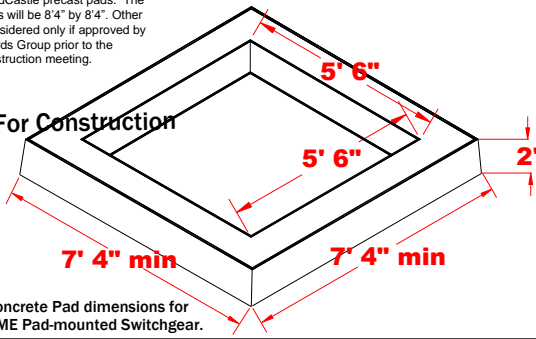

Figure 26: Concrete Pad dimensions for all PMH and PME Pad-mounted Switchgear.



4D (UG): Arrange Inspection of Primary Trench, Conduit and Meter Base

All prerequisites outlined in this document (signing up for service, paying deposits, etc.) shall be completed before a ditch will be inspected. Contact the NES ditch inspector whose name and number is given at the Pre-Construction Meeting. The NES ditch inspector will inspect the job for compliance with NES’s requirements. The inspection shall be done before any backfilling of the trench.

4E (UG): Backfill Primary Trenches

After NES approves the conduit and meter base installation, backfill the trench twelve inches (12”) with #67 crushed gravel above galvanized conduit (or pour concrete if using PVC conduit).

Checklist for proper backfill:

- Ditch contains no solid material larger than two inches (2”) in diameter.
- Ditch is free from stones, rocks, or other material which could damage the conduit.
- #67 gravel is required twelve inches (12”) above and six inches (6”) below the conduit.

4F (UG): Arrange Inspection of Backfill, Grade Property

Once PVC conduit has been concrete encased, or trench has been backfilled twelve inches (12”) if rigid galvanized steel is used, contact the NES ditch inspector who did the previous inspection. The NES ditch inspector will check the encasement or backfill. If changes are necessary, complete the requested alteration(s) and again call the inspector. When the encasement or backfill is approved, the inspector will install the warning tape. The trench may then be backfilled to finished grade.

4G (UG): Arrange Installation of Cables and Equipment by NES

The Customer is expected to install commercial secondary and service if served from a pad-mounted transformer. The Customer may select any wire size, however if the Customer selects a wire size for which NES does not stock termination lugs, the Customer shall supply the termination lugs.

NES stocks lugs for the following sizes (aluminum or copper):

| | | | | |
|-----|-----|-----|-----|-----|
| #1 | 2/0 | 4/0 | 250 | 300 |
| 350 | 400 | 500 | 600 | 750 |

! NES does not stock lugs for compacted wire.

C**Electric Service Guidelines**

NES will begin installation of primary conductor and equipment, and make proper connection of the cable at the secondary bushing of the transformer, when the following are completed:

- Property where NES equipment is located shall be at final grade.
- If an all-weather road was required at the Pre-Construction meeting, it shall be completed.
- All requested easements shall be recorded or an agreement to furnish and record all requested easements shall be signed by the developer.
- There shall be evidence of construction.
- There shall be payment of a Contribution in Aid of Construction, if required.
- Codes release shall be received by NES before service can be energized.

! Equipment relocations after installation due to changes in final grade, improper location, or other conditions, shall be at the Customer's expense.

Once these conditions are met, NES will install the primary conductor into the conduit, and will install any equipment required. NES will connect the Customer's secondary inside the pad-mounted transformer, and ground the transformer. If the Customer is installing service directly from the pole to the meter, NES will install the service conductor.

The NES Meter Department will install the meter. NES will not energize the line until all required deposits or fees have been paid.



CHAPTER V: METERING

CUSTOMER METERING AND WIRING STANDARDS

All meter bases, meter centers, breaker boxes and wiring installed by the customer shall conform to all applicable codes and ordinances, as exemplified by the requirements of the National Electrical Safety Code and the National Electrical Code. The customer shall at all times maintain the meter bases, meter centers, breaker boxes, wiring and equipment furnished by the customer, in such condition and repair as may be required by NES and by any statute, law, city ordinance, or code. All NES approved meter bases can be found at www.nespower.com under the Builders and Contractors tab.

See page 71, 75, and 78 for all working clearances. In addition any meter with a bypass handle requires 36" clearances to the right of the meter base excluding electrical equipment that does not exceed 6" of depth difference.

No electrical meter room will be allowed inside without prior written NES Meter Department approval. Approval must be obtained before construction has begun.

If a meter(s) is enclosed or otherwise made inaccessible after installation, without written approval from the NES Meter Department, the Customer will bear the cost for having the metering facilities moved to an accessible location.

NES does not provide metering on pad mounted transformers. Services fed from a pad mounted transformer that require CT metering will require a CT cabinet at the service entrance to the building, or a switchboard with a metering bay approved by Meter Department. Customer will be required to provide the CT cabinet as well as the meter base for the service. See Figure 13 on page 39 or figure 19 on page 55 of the Electric Service Guidelines for example installations for the CT cabinet and meter base.

Meters and related equipment shall be adequately protected from physical damage.

If you are interested in installing any type of generation system such as Solar, Wind etc. please contact NES Customer Engineering, NES Meter Department and NES Energy Services BEFORE purchasing or installing any of this type equipment.

Metering equipment shall not be located on the load side of a customer owned transformer.

There shall be no access to unmetered conductors such as: troughs, wire ways, LB's, gutters, pull boxes, etc.



Electric Service Guidelines

! All NES approved meter bases can be found at www.nespower.com under the Builders & Contractors tab. Contact the NES Meter Department (615) 747-3805 with any metering concerns or questions.

It has been determined by NES that the by-pass handle mechanism in an Anchor meter socket is dangerous, and prone to catastrophic failure when operated by utility personnel. For the protection and safety of NES personnel, the NES Meter Department considers all Anchor brand bases with a bypass handle condemned at the time the meter is removed from the socket due to the account being finaled at the Customer request, or the account is cut off for nonpayment. It is the Customer's responsibility to replace with an approved meter base.

NES does not allow the use of a 600 amp self-contained meter base (K-7 meter base). A K-7 base cannot be repaired, or be replaced with a K-7 base. For the protection and safety of NES personnel, the NES Meter Department considers all Anchor brand bases with a bypass handle condemned at the time the meter is removed from the socket due to the account being finaled at the Customer request, or the account is cut off for nonpayment. It is the Customer's responsibility to replace with an approved meter base.. The service must be replaced with a CT rated service.

Class 320 meters cannot be used to permanently serve buildings that are used for commercial purposes. Other buildings on residential property which are billed by NES as "commercial" accounts, may use Class 320 meters.

The Customer is responsible for providing and installing all service equipment other than the meter. All meter bases, enclosures, and conduit must be bonded and grounded in accordance with current NEC

CED
330 19th Avenue North
Nashville, TN 37203
(615) 329-2601

Stuart C. Irby
1284 Heil Quaker Blvd
LaVerne, TN 37086
(615) 280-3300

Border States Elec.
656 Wedgewood Ave.
Nashville, TN 37202
(615) 255-4161

WESCO
1400 Ft. Negley Blvd.
Nashville, TN 37203
(615) 248-9713

Mayer Electric Supply Co. Inc.
2924 Sidco Dr
Nashville, TN 37204
(615) 242-1100

Williams Wholesale Supply
831A Cowan Street
Nashville, TN 37207
(615) 324-0469

Codes. **All meter bases and/or CT enclosures shall be grounded with a minimum #4 copper wire.**

Any vendor may be used to supply the meter base provided they meet the requirements outlined in this section. The below vendors are known to carry NES and NEC approved meter bases:

NES reserves the right to trim or remove any landscaping, signs or other items interfering with the operation or maintenance of metering equipment. This may be necessary to restore or maintain service, and/or to ensure NES employee safety.



METERING REQUIREMENTS LOOK-UP TABLE

Find the service type being metered, and compile all of the requirements listed on the following pages. Using the resulting lists will ensure the meter base purchased meets all NES requirements. All other meter related questions should be directed to the Meter Department directly at (615)747-3805.

| Service Type | Service Size | Lists that apply |
|--|----------------|---|
| Single-phase, 120/240 Volt, Temporary Service or Residential | | |
| Overhead or Underground | Up to 225 amps | Single-Phase Self-Contained Meter Base Requirements |
| | 226 - 400 amps | Class 320 Meter Base Requirements Class 320 Underground Requirements |
| | Over 400 amps | CT Rated Meter Base Requirements |
| Single-phase, 120/240 Volt, Residential Service Only | | |
| Overhead | Up to 225 amps | Single-Phase Self-Contained Meter Base Requirements |
| Underground | Up to 225 amps | Single-Phase Self-Contained Meter Base Requirements Underground Meter base requirements |
| Overhead | 226 - 400 amps | Single-phase Self-contained Meter Base Requirements Class 320 Meter Base requirements |
| Underground | 226 - 400 amps | Single-phase Self-contained Meter Base Requirements Class 320 Meter Base Requirements Class 320 Underground Requirements |
| Overhead or Underground | Over 400 amps | CT Rated Meter Base Requirements 8 – Terminal 5S CT rated base unless otherwise specified by NES |
| Single-phase, 120/240 Volt, Commercial Service | | |
| Overhead or Underground | Up to 200 amps | Single-Phase Self-Contained Meter Base Requirements |
| | Over 200 amps | 8 – Terminal 5S CT rated base |
| Single-phase, 120/208 Volt, Permanent Residential | | |
| Overhead or Underground | Up to 225 amps | Single-phase Self-contained Meter Base Requirements <i>Include a fifth terminal set at 9:00 position</i> |
| | 226-400 amps | Class 320 Meter Base requirements <i>Include a fifth terminal set at 9:00 position</i> |
| | Over 400 amps | CT Rated Meter Base Requirements |
| Single-phase, 120/208 Volt, Temporary or Permanent Commercial | | |
| Overhead or Underground | Up to 200 amps | Single-phase Self-contained Meter Base Requirements <i>Include a fifth terminal set at 9:00 position</i> |
| | Over 200 amps | CT Rated Meter Base Requirements |
| | 201-400 amps | Class 320 Meter Base requirements (Temporary Only) <i>Include a fifth terminal set at 9:00 position</i> |
| Three phase, 120/2Y or 277/480Y Volt Services | | |
| Overhead or Underground | Up to 200 amps | Three-phase Self-contained Meter Base Requirements <i>Seven-terminal base (HQ7) with a manual bypass block Grounded neutral conductor connected or tapped to the third terminal from the left on the lower terminals</i> |
| | Over 200 amps | CT-rated Meter Base Requirements <i>Thirteen-terminal meter base (9S) with test switches Disconnect installed behind the meter base 3 CT's (480Y/277 voltage also requires a 2.5:1 PT, CT's and PT's are supplied by NES).</i> |



Electric Service Guidelines

SINGLE PHASE SELF-CONTAINED METER BASE REQUIREMENTS

All meter bases **must** be on approved meter base list (Go to www.nespower.com, Builders & Contractors tab).
In addition, meter bases must:

- Be UL (Underwriters Laboratory) approved
- Be ringed type (unless meter base is a Class 320 with a by-pass handle).
- Have four meter jaws and one connection point for the neutral conductor.
- **Center of meter must be mounted at 5'- 6" from final grade.**
- Be rated for exterior use, and be weather proof according to NEMA-3R.
- Have all unused openings closed with plugs that are locked tightly in place from inside the base or enclosure.
- Be level, plumb and securely fastened to the supporting structure.
- Be bonded and grounded in accordance with Articles 230 and 250 of the latest edition of the NEC (when self-contained meter bases are used, the neutral conductor must be connected to the neutral terminal in the base).
- NES will not energize a meter base with built in breakers, (temporary or permanent service), the only exception will be multi-gang load centers.
- Be covered and sealed with a transparent cover plate when a meter is not installed if the base contains energized equipment.

UNDERGROUND METER BASE REQUIREMENTS

In addition to single-phase self-contained meter base requirements, underground meter bases for 120/240 Volt, 200 Amp services, **Shall:**

- *Be left-side connected from approved meter base list available on www.nespower.com. **Line and load conductors shall not cross each other in base.***
- Accept three inch (3") rigid galvanized steel or schedule 80 PVC conduit.
- Include pull strings in any underground service conduit.
- Have lugs (electrical connectors) that are marked to accept 4/0 aluminum conductors.
- *Use the left side concentric knockout (because of the bending radius of the cable).*

CLASS 320 METER BASE REQUIREMENTS

In addition to single-phase self-contained requirements, Class 320 meter bases for 120/240 Volt, 400 Amp or 120/208 Volt Network, 400 Amp services, **must:**

- Be rated for 120/240 Volt or 120/208 Volt (Network) and 320 Amps continuous.
- Contain a Class 320 manual bypass block with **36" of working clearance to the right of the handle.**

CLASS 320 UNDERGROUND METER BASE REQUIREMENTS

In addition to single-phase self-contained and Class 320 meter base requirements, Class 320 meter bases for underground services, **must:**

- Have lugs that accept 350 MCM aluminum wire
- Accept three-inch (3") rigid galvanized steel or schedule 80 PVC conduit, through a knockout at the bottom left corner of the enclosure.
- Include pull strings in any underground service conduit.
- Have at least eight and one-half inches (8 ½") of clearance between the bottom of the lugs and the bottom of the enclosure.

NES will not energize a meter base with built in breakers, (temporary or permanent service), 1 exception will be multi-gang load centers.

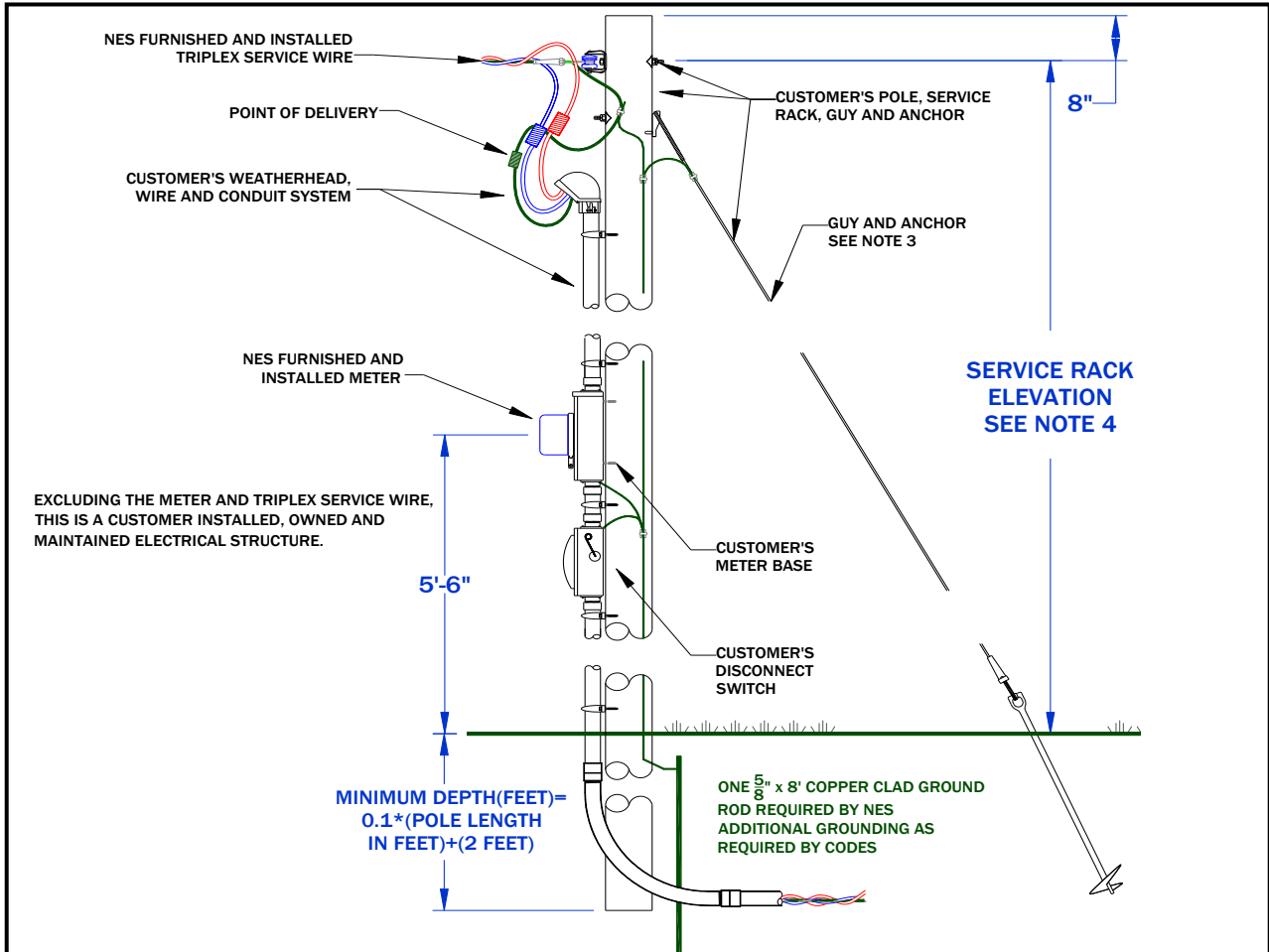

Drawing Notes:

1. Installation shall meet all NEC and local Codes.
2. A meter pole may be used for individual metered services such as mobile homes. Meter pole shall be of sufficient diameter, height, and strength to safely serve its intended purpose for the life of the installation. The meter pole shall be a round pole. Poles with profiles other than cylindrical are unacceptable.
3. An anchor and guy wire may be required for longer services, as specified by the NES Engineer.
4. Service rack elevation shall provide the following service wire clearances :
 - **Eighteen feet (18')** over roadways
 - **Sixteen feet (16')** over driveways
 - **Twelve feet (12')** over property that is not subject to any vehicle traffic or horseback riders
5. The Customer is responsible for stabilization of the soil during excavation.
6. A working space of thirty-six inches (36") wide by thirty-six (36") deep is required in front of the meter equipment. This space is to be kept clear of any obstructions including mature-growth landscaping.
7. Customer meter pole shall not be located within ten feet (10') of NES pole.

Figure 28: Overhead Customer Meter Pole

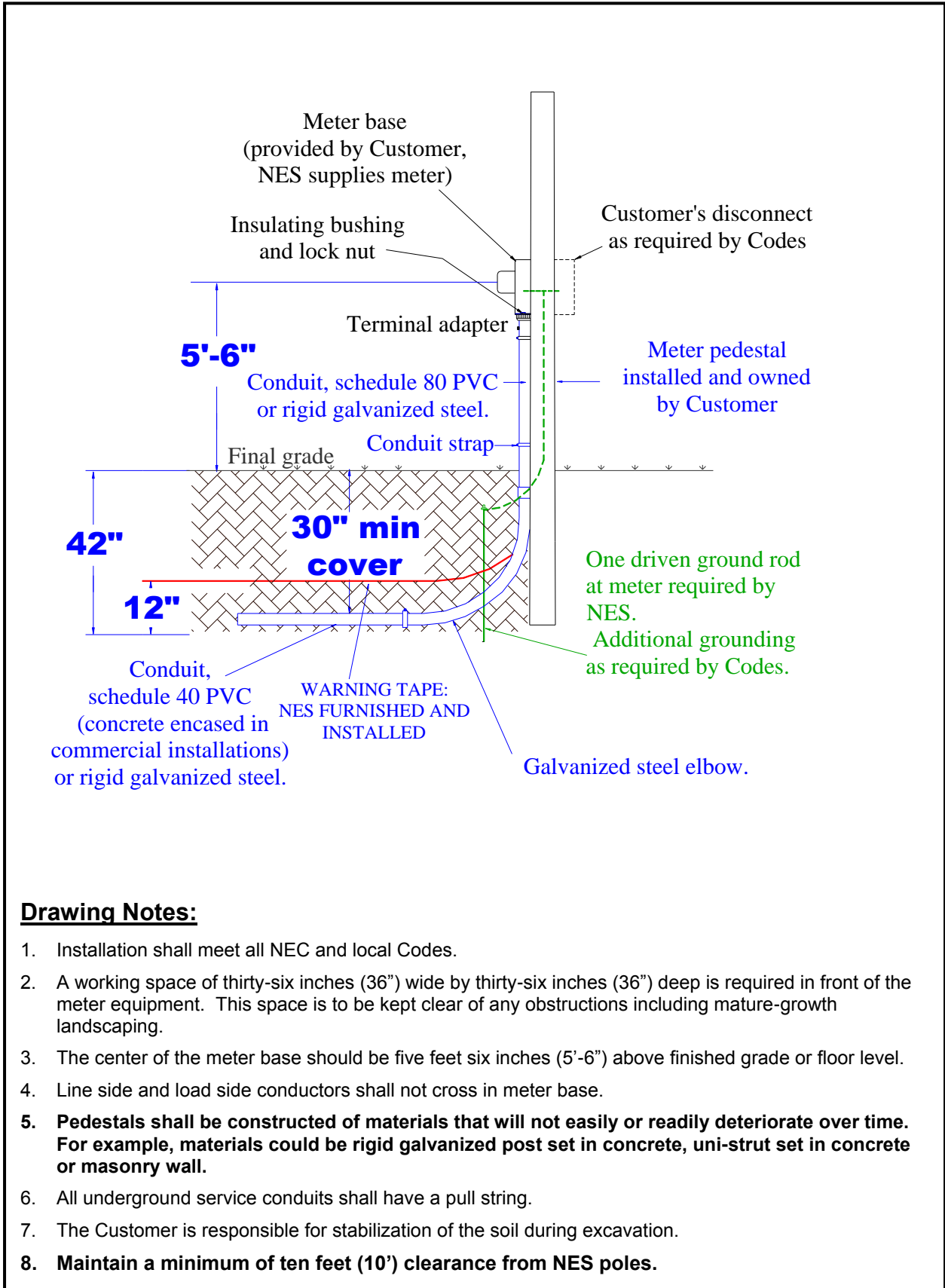
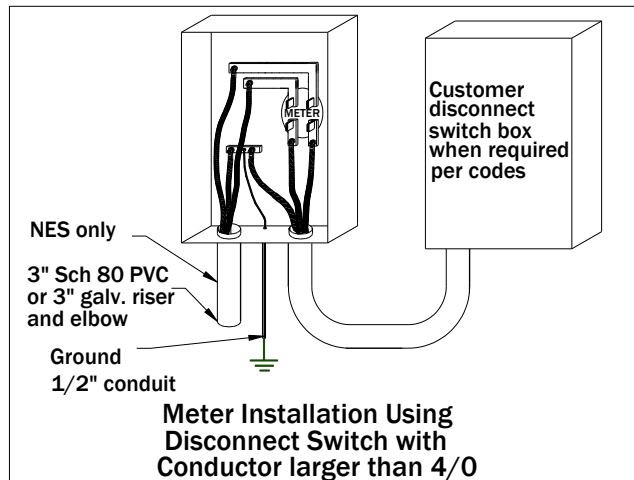
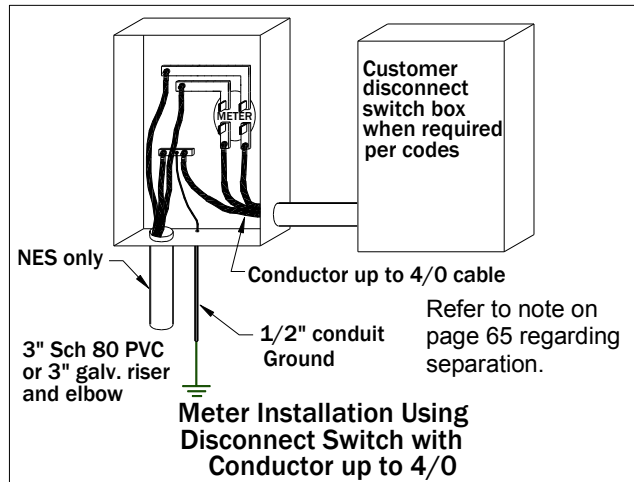
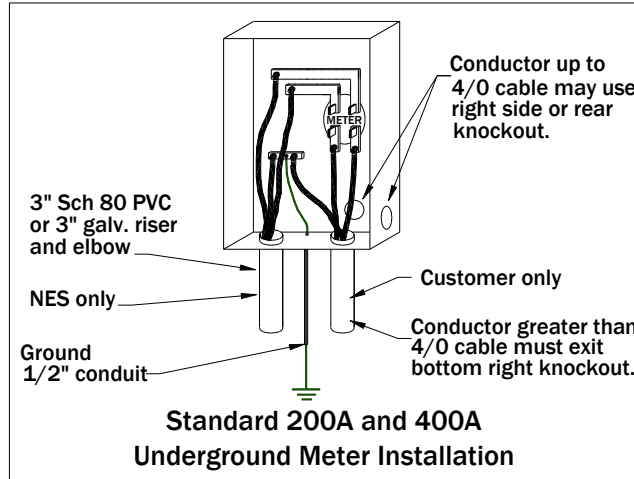

Figure 29: Underground Customer Meter Pedestal



Drawing Notes:

1. Meter bases not in accordance with NES standards will not be energized.
2. Line side and load side conductors shall not cross in the meter base.

Figure 30: Residential Underground Meter Connections

M

Electric Service Guidelines

MULTI-FLOOR & HIGH RISE METERING

Requirements are applicable for all buildings larger than three stories.

- Download the Multi-floor and High Rise Metering infrastructure requirements and details at www.nespower.com under the Builders and Contractors tab.
- No electrical meter room will be allowed inside without prior written NES Meter Department approval. Approval must be obtained before construction has begun.
- **Meter rooms located inside shall not be any closer than one per three floors.** See Figure 31.
- All residential meter centers shall be modular grouped installations with individual meter breakers. The approved meter base list can be found at: <http://www.nespower.com/guidelines.html>. Such equipment shall be reviewed and approved by the NES Meter Department prior to making commitments for the purchase and installations of such equipment. **Buss extensions may be needed extending from the breaker or main lug section. Check with meter department before installing.**
- All meter locations shall be subject to NES approval .
- Meter Base Sockets may be located inside an electrical equipment room which is used solely for power equipment. Spaces dedicated as meter rooms shall have no other items in, or passing through, the meter room that is not associated with the NES metering.
- NES requires a location near the door for installation of a **Key box**, a key fitting the equipment room door for the key box, and a sign on the exterior door stating "Electrical Room #xx." If multiple equipment rooms are needed, each equipment room door shall have a dedicated key box with key. If door locks are changed, contact NES Meter Department at (615) 747-3805 to coordinate the exchange of new keys.

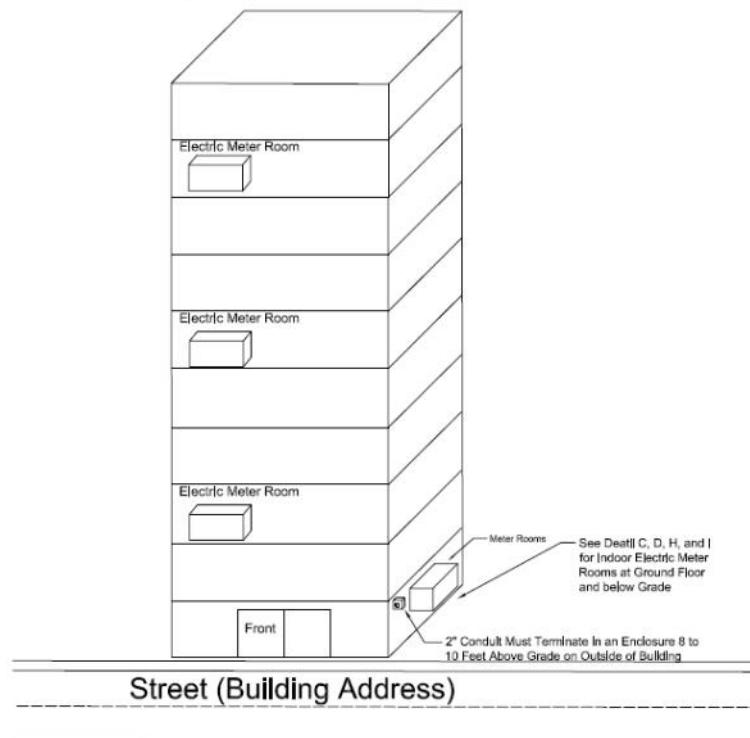

Figure 31: Multifloor Metering



Electrical Room Requirements

No electrical meter room will be allowed inside without prior written NES meter department approval. Approval must be obtained before construction has begun.

The electrical room shall have a door accessible to a public area. The electrical room shall be well lit and accessible during normal business hours (7:00 am until 4:30 pm). The size of the door shall be a minimum of two feet - eight inches (2'-8") by six feet - eight inches (6'-8").

Meter Base Sockets shall be located inside an electrical equipment room which is used solely for power equipment. Spaces dedicated as meter rooms shall have no other items in, or passing through the meter room that are not associated with NES metering.

Customer is responsible for:

- Purchasing and installing a four inch by four inch (4"x4") stainless steel key box adjacent to each **'Electrical Meter Room'** door with provisions for a NES padlock (7/16th" shank).
- Customer must provide a map for all **'Electrical Meter Room'** locations on the inside of associated meter room door of all Electrical Meter Rooms.
- Following any upgrade or change to an existing meter room service the customer will be required to upgrade room access with key box, as well as any Advanced Metering Infrastructure (AMI) requirements.
- All metering services shall meet all working clearances as defined in Figure 33 in the meter section of this manual.
- Providing a key to be placed inside the box which allows access to the electrical meter room.
- Installing a sign on the exterior door saying **"Electrical Meter Room"**

Failure to meet electrical room requirements will cause electric service to be disconnected until requirements are met.

Metered Circuit Requirements

- Sufficient clearance for adequate cable bending radius shall be provided to avoid placing undue strain on the terminal facilities.
- Terminals shall be rated for the conductor size being used.
- Strands shall not be removed from the conductor in order to fit under-sized terminals.
- **When a three-phase transformer provides single-phase 120/208 Volt service, it is the Customer's responsibility to add a 5th terminal in the 9 o'clock position on the meter base as well as identify the conductors and balance the load on the transformer. This is provided by the customer.**
- Line-side conductors shall always be connected to the top terminals of the meter base. **Line and load conductors shall not cross in the base.**
- Service conductors shall be arranged in the base to avoid interfering with the meter installation or operation of the bypass blocks.
- Current limiting fuses shall not be installed in meter bases, instrument transformer enclosures, or NES distribution transformers. Current limiting fuses shall be installed in the Customer's service panel, or in a separate enclosure between the base and the panel.

Customer Owned-Meter Poles and Pedestals

If the meter base needs to be attached to a separate structure instead of directly on the building, the Customer is responsible for the purchase and installation of the meter pole or pedestal, and related equipment as shown in Figure 28 on Page 69 for overhead service, and in Figure 29 on Page 70 for underground service. The Customer retains ownership of the equipment.

The location requirements for this equipment are the same as those listed in this section for a meter base.

Service to Fire Pumps

Service to fire pumps shall be metered three-phase, four-wire, wye, with CT's. **A neutral is required in the CT cabinet.**



Electric Service Guidelines

METER TROUGHS AND SECONDARY TERMINATION ENCLOSURES

For the protection and safety of NES personnel, NES shall not connect to any new troughs. Troughs shall be replaced with a termination enclosure (provided by the Customer) under the following circumstances: Adding load, upgrading service, adding a new service, or replacing NES line side conductors. NES will still connect a finalized account provided that the amperage does not exceed the meter base rating. Secondary terminating cabinets may be required on commercial services where multiple CT rated services will be used. This determination will be made by the NES engineer when the job is designed.

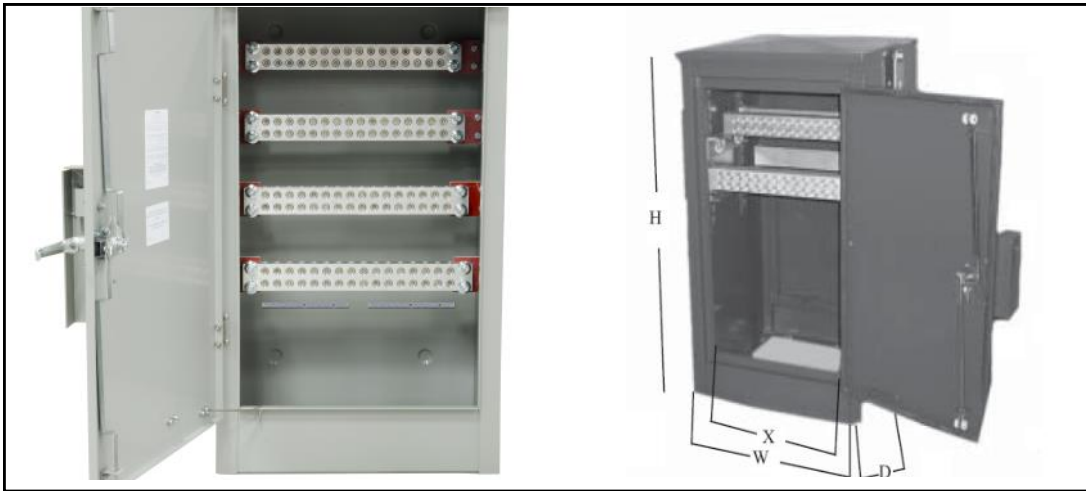

Figure 31: Secondary Termination Enclosures
(left: Milbank Multi-Position Tap Box, right: CMC Type LPTE)

Terminating cabinets can be purchased at local electrical distributors such as the ones listed on page 19. More information on termination enclosures can be provided at the Pre-Construction Meeting. Termination Cabinets are the property of the Customer. NES requires an NES lock on these cabinets. The NES Meter Department (615)747-3805 will unlock cabinet for the Customer when necessary. The following are acceptable part numbers.

| | Max Wire Size | Number of Lugs | W | D | H | Maximum UL Rating | |
|-----------------------|---------------|----------------|----------------------|----|----|-------------------|----------|
| Milbank Part # | | | Dimensions in inches | | | | |
| UAP6094-O-NES | 500 kcmil | 16 | 25 5/8 | 16 | 43 | 3000 amps | |
| UAP6095-O-NES | 500 kcmil | 22 | 32 3/8 | 16 | 43 | 4000 Amps | |
| UAP6096-O-NES | 750 kcmil | 14 | 25 15/16 | 16 | 51 | 3300 Amps | |
| CMC/ESP Part # | | | | | | Copper | Aluminum |
| LWTE21-500 | 500 kcmil | 21 | 32 | 16 | 51 | 3800 | 3100 |
| LWTE14-750 | 750 kcmil | 14 | 32 | 16 | 51 | 3325 | 2695 |
| LWTE14-1000 | 1000 kcmil | 14 | 32 | 16 | 51 | 3815 | 3115 |

Each individual service in the termination cabinet shall be labeled by unit number, apartment number, suite number, space number, on the service cable for disconnect/reconnect purposes. All conductors Shall be routed behind the termination cabinet buss work.

! A disconnect is allowed in front of a termination enclosure, but is not allowed between the termination enclosure and meter.

THREE-PHASE SELF CONTAINED METER BASE REQUIREMENTS

All meter bases must be on approved meter base list on www.nespower.com.

Commercial meter bases shall:

- Center of meter base must be mounted at 5'- 6" from final grade.
- Be UL (Underwriters Laboratory) approved.
- Be rated for exterior use, and be weather proof according to NEMA-3R.
- Have all unused openings closed with plugs that are locked tightly in place from inside the base or enclosure.
- Be level, plumb and securely fastened to the supporting structure.
- Be bonded and grounded in accordance with Articles 230 and 250 of the latest edition of the NEC (when self-contained meter bases are used, the neutral conductor shall be connected to the neutral terminal in the base).
- Not be jumpered to provide power.
- Have terminals marked with a conductor range for aluminum or copper conductors (When aluminum conductors are used, the base shall be approved and clearly marked by the manufacturer for that use).
- Be covered and sealed with a transparent cover plate when a meter is not installed if the base contains energized equipment.
- All underground service conduits shall have a pull string.
- Have a manual bypass block with 36" of working clearance to the right of the handle.

It has been determined by NES that the by-pass handle mechanism in an Anchor meter socket is dangerous, and prone to catastrophic failure when operated by utility personnel. For the protection and safety of NES personnel, the NES Meter Department considers all Anchor brand bases with a bypass handle condemned at the time the meter is removed from the socket due to the account being finalized at the Customer request, or the account is cut off for nonpayment. It is the Customer's responsibility to replace with an approved meter base.

! NES will not energize a meter base with built in breakers, (temporary or permanent service), the only exception will be multi-gang load centers.

NES does not allow the use of a 600 amp self-contained meter base (K-7 meter base). A K-7 base cannot be repaired, or be replaced with a K-7 base. For the protection and safety of NES personnel, the NES Meter Department considers all Anchor brand bases with a bypass handle condemned at the time the meter is removed from the socket due to the account being finalized at the Customer request, or the account is cut off for nonpayment. It is the Customer's responsibility to replace with an approved meter base.. The service must be replaced with a CT rated service.



Electric Service Guidelines

CURRENT TRANSFORMER (CT) RATED METER BASE REQUIREMENTS

NES provides the actual Current Transformers. The Customer **shall** pick up the CT's from the NES Meter Department (615) 747-3805 before purchasing a base. This provides the Meter Department time to assist the Customer in selecting the correct CT-rated base which should be purchased. The table below gives general guidelines:

| If the service is: | Base needed: |
|---|----------------------------------|
| 3 wire single phase service (with 2 CT's) | Form 5S, 8 terminal |
| 4 wire three phase service (with 3 CT's) | Form 9S 13 terminal meter socket |

Customer is required to purchase the CT-rated meter base. Approved meter base list is located at www.nespower.com under the Builders & Contractors tab.

In addition:

- Mount metering cable weatherhead at least six inches (6") above the highest mounted CT.
- Locate the meter base no more than thirty feet (30') from the CT's.
- CT and PT brackets shall be mounted either on the service conductor riser, or between the service conductor riser and the point of attachment.
- Overhead services require heel-to-heel mounting bracket (provided by NES) for CT and PT installation. The bracket may be mounted to the building structure or a riser.
- **For ALL CT-rated services provide conductor long enough to pass through the CT's and an additional twenty-four inches (24") of conductor past the CT's.**
- Install the CT cabinet such that top of the CT cabinet is a maximum of six feet and eight inches (6'-8") above the floor or finished grade and the bottom is a minimum of eighteen inches (18") above the floor or finished grade. CT cabinets must not be mounted in crawl spaces, attics, any confined areas, or mounted on ceilings.
- **All metering conduit must be rigid galvanized steel.**
- **Remove all concentric knock outs and install rigid galvanized steel conduit** between the meter base and CT location unless it is an overhead service. For overhead services use a one inch (1") rigid galvanized steel conduit in the supplied hub up to the CT location. Conduit must be as short as possible, and must not exceed thirty feet (30') in length. Flex conduit is **not** acceptable in meter circuits. The conduit must not contain condulets, tees, or junction boxes. **Conduit shall not contain any screw connectors or compression fittings. All conduit shall be threaded.**
- Conduit shall not be used for grounding, or any other purpose, other than NES metering cable.
- For underground services only, customer shall install CT cabinet, including lockable hinged door. Cabinet must not block a safe exit while open. Customer shall provide the CT cabinet.

! A disconnect is allowed in front of a termination enclosure, but is not allowed between the termination enclosure and meter.



Figure A



Figure B



Figure C

FUNCTIONS AND ORIENTATIONS OF A CURRENT TRANSFORMER (CT)

A current transformer (CT) is used to measure the current flow in a conductor or group of conductors. Every CT also has a primary side which must be where the line side of the conductor(s) enter the CT opening. This may also be referred to as the utility side, source side, transformer side, or line side, and it is of great importance to have this installed correctly. **The primary side (above the window or opening) of a CT is marked with either H1 or a white dot that is usually within a raised ring or bump (see Figures above).** A white dot or X1 at the secondary terminals (set screw connections) has no influence on the direction of mounting the CT's (see Figures above). The white dot at the secondary terminals is only for CT-to-meter wiring references.

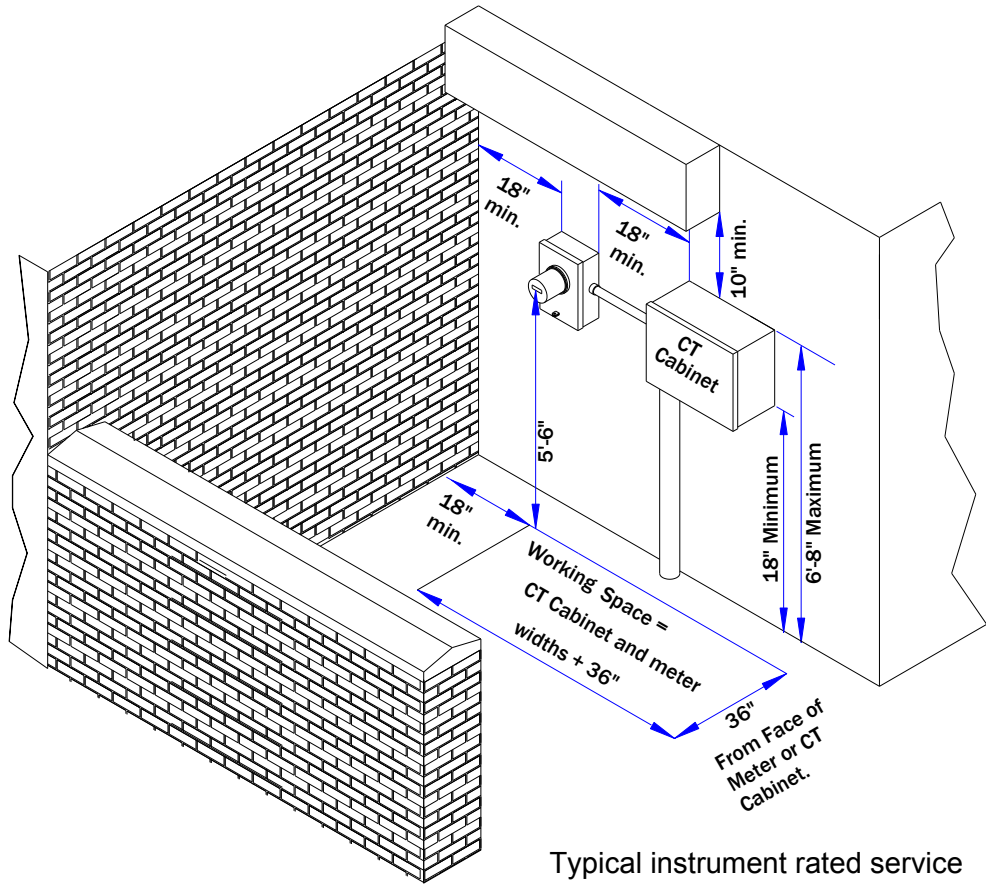

Typical instrument rated service requires 100 linear inches of wall space for metering equipment.

Drawing Notes:

1. Installation shall meet all NEC and local Codes.
2. Working space shall be provided for equipment maintenance at all times. Minimum working area extends eighteen inches (18") beyond both sides of the total width of the meter and CT cabinet installation and projects thirty-six inches (36") out from the surface of the CT cabinet or meter.
3. There shall be open access to the meter assembly for Meter Readers and Maintenance Personnel.
4. Do not install any obstruction above the meter base. NES equipment may be installed such as a CT cabinet below the meter base as long as it meets local code ordinances, and NES minimums as defined in Figure 33 of this manual. **There shall be no other utility meters (such as gas), air conditioners, or other non-NES obstructions installed directly below the meter base. Any other installations should have a minimum eighteen inches (18") of horizontal clearance from the meter base.**
5. NES equipment may be installed such as a CT cabinet below the meter base as long as it meets local code ordinances, and NES minimums as defined in Figure 36 of this manual.
6. The edge of all meter base enclosure shall be a minimum of eighteen inches (18") from adjacent walls, ceilings, gas meters and related piping, or any other similar obstruction. All service equipment, additional meter bases, including disconnect switches shall be a minimum of eighteen inches (18") from the edge of the meter socket.

Figure 33: Meter Clearances

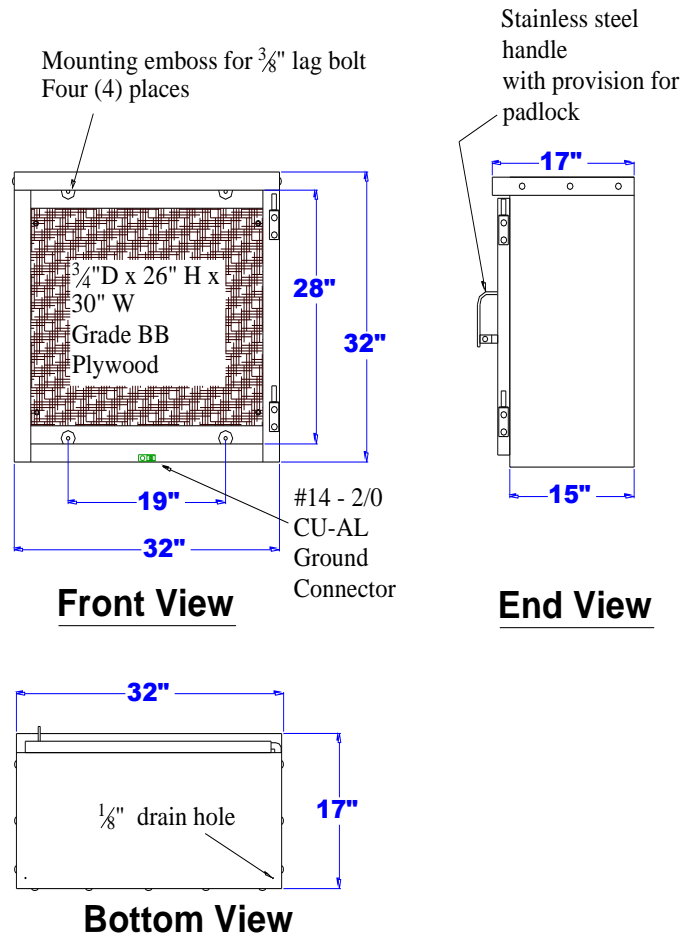

Figure 34: Current Transformer (CT) Cabinet

Drawing Notes:

1. CT cabinets are required for underground services only.
2. NES-approved CT cabinet shall be provided by Customer.
3. **Contact the NES Meter Department (615-747-3805) for prior approval of alternate cabinet size where space requirements are critical.**
4. Construction material is 100 5052-H32 aluminum. Finish is natural aluminum.
5. All hardware and hinges are stainless steel.
6. Doors are to be removable.
7. All flanges are to be one inch (1").
8. All conductors passing through a CT cabinet shall be marked with phasing tape.
9. All conduit in CT cabinet shall be marked Line / Load using a permanent marker.
10. The Customer shall provide a #4 AWG copper wire from the ground rod to the grounding block inside the CT cabinet.
11. CT cabinets shall be bonded in compliance to the current NEC book.
12. 24" of conductor tail must pass through the CT's
13. All underground service conductor conduits shall have a pull string.
14. Any conduits entering or exiting the top of the CT cabinet shall be water proof.
15. If equipment is stacked, *check with local inspector for approval.*



Electric Service Guidelines

SWITCHGEAR METERING-LESS THAN 600 VOLTS

- **All switchgear metering designs shall have prior approval by NES Meter Department.**
- All switchgear metering shall be hot sequenced. (breakers and disconnects after the meter bay)
- **Ask about fire pump section, after meter, before breaker.**
- Shall be bottom feed through the metering compartment.
- All metering bays in switchgear must be of sufficient size to mount CT's and PT's in the metering bay, and secure the compartment with a NES padlock (7/16" diameter).
- All CT's and PT's in switchgear must be issued by NES Meter Department.
- Metering equipment mounted in metering bay shall be no lower than eighteen inches (18") from final grade and no higher than six feet (6') from final grade.
- CT secondary termination must be mounted so that its between the bus and the door with no other obstructions.
- CT's must be supported and not affixed to a nonconductive shelf.
- On 480V services, PT's shall either be mounted in the same bay as the CT's or in a lockable bay just above or below the CT bay, and must be easily accessible from the front.
- All busses in the metering bay used to pass through the CT's shall be no larger than four inches (4"). Any other size buss must be approved by NES Meter Department prior to ordering the gear.
- All metering equipment shall be mounted by electrical contractors.
- NES Meter personnel will make all meter equipment secondary connections.
- Customer shall provide UV- rated placard denoting the voltage in the metering compartment.

SWITCHGEAR METERING PRIMARY

- **All primary switchgear metering designs shall have prior approval by NES Meter Department.**
- All switchgear metering shall be hot sequenced. (breakers and disconnects after the meter bay)
- All metering bays in switchgear must be of sufficient size to mount CT's and PT's in the metering bay, and secure the compartment with a NES padlock (7/16" diameter).
- All CT's and PT's in switchgear must be issued by NES Meter Department.
- All metering equipment shall be mounted by the switchgear manufacturer.
- Switchgear manufacturer will make all the primary side connections.
- NES Meter personnel will make all meter equipment secondary connections.
- Customer shall provide UV rated placard denoting the voltage in the metering compartment.



METER IDENTIFICATION AND TAGGING POLICIES

1. Any premise, address, or lot that has multiple metered services shall be required to properly tag and identify each individual metered service that corresponds with NES billing information.
2. All identification tags shall meet the following requirements:
 - Be outdoor rated brass or stainless steel. Trophy brass, or brass plated **will not** be accepted.
 - Minimum tag size shall be one by three inches (1"x3").
 - Minimum character height shall be one half inch (1/2").
 - Characters shall be stamped or CNC machined.
 - Tags shall be attached with either rivets or screws.
 - On a single meter base application the tag shall be attached on the face of the meter cover.
 - On a multi-gang meter center the tag shall be attached to the front panel center beneath the main breaker.
 - On any multi-gang meter center that has multiple breakers covered, the tag shall be attached to the appropriate side on the meter center at approximate height of the meter.
 - The alpha numeric phrase on the tag shall include the apartment, building number, or street address that corresponds with NES billing information.

3. Any maintenance, repairs, or replacement of multi-gang meter bases shall be required to be identified by an approved NES tag.

4. Any vendor may be used to supply the meter base identification tags provided they meet the requirements outlined in this section, and **been pre-approved by NES Meter Department prior to tag installation.** The vendors below are known to carry approved NES identification tags

| | |
|--|--|
| Demented Tags 509 N Graycroft Ave. Madison, TN 37115-2508 (615) 300-8186 | Madison Trophy Shop 932 Madison Square Madison, TN. 37115 |
| The Engraving Company 150 Pewitt Drive Brentwood , TN 37027 (615) 373-3662 | Border States Elec. 656 Wedgewood Ave. Nashville, TN 37202 (615) 255-4161 |
| Donelson Trophy 2616 Lebanon Pk Nashville, TN 37214 (615) 885-2846 | E & J Engraving 7766 Highway 100 Bellevue ,TN 37221 (615) 405-0800 |
| Specialty Engraving Company P.O. Box 131 3042 York Rd Pleasant View, TN 37146 (615) 351-1962 | |

5. **Owners or management companies are responsible for NES time spent investigating, billing, and/or correcting crossed meters due to unmarked or incorrectly marked bases.**
6. **All tagging shall coordinate with postal plan.**



Electric Service Guidelines

MULTIPLE METER INSTALLATIONS (“GANG METERS”)

Multi-unit, or “gang” meters, shall be labeled to identify the part of the premises they serve before service will be energized (as shown in Figure 30 below).

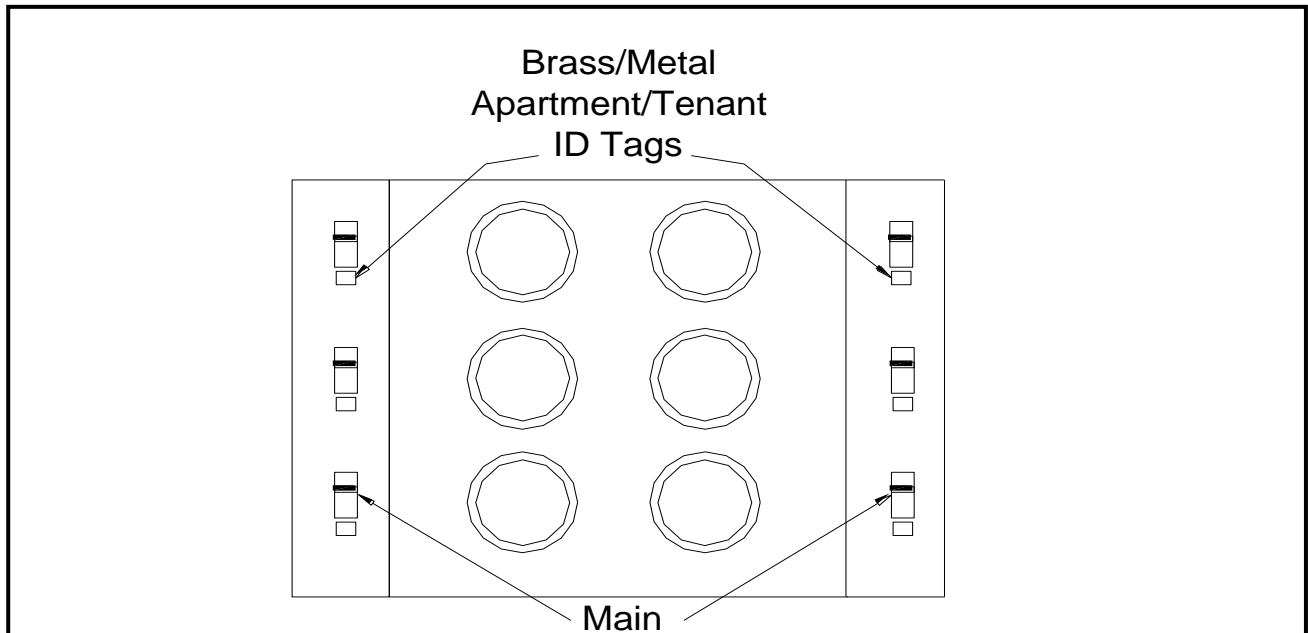

Drawing Notes:

1. Multi gang meter bases shall be listed on the approved meter base list at www.nespower.com
2. **Any maintenance, repairs, or replacement of multi-gang meter bases shall be required to be identified by an approved NES tag.**
3. ID Tags shall be outdoor rated brass, or stainless steel.
4. Identification tags shall be a minimum of 1" x 3" and shall be **stamped, or CNC Machined** with a minimum character of 1/2" in height.
5. **Owners or management companies are responsible for NES time spent correcting crossed meters due to unmarked or incorrectly marked bases.**
6. The center of the gang base shall be approximately five feet (5') above the floor or finished grade
7. Maximum numbers of vertical meters shall not exceed five (5).
8. Meters and related equipment shall be adequately protected from physical damage.
9. Meter pedestals shall be constructed of materials that will not easily or readily deteriorate over time. For example, materials could be rigid galvanized post set in concrete, uni-strut set in concrete or masonry wall. Gang meter base (s) shall not be mounted on any wood pedestal.
10. Maximum individual service size in a gang meter center is up to 225 Amps.
11. **No Surge Protection on the line side of any meter service.**
12. **Buss extension may be required. Check with NES Meter Department before ordering and installing.**
13. **Residential single phase fed from a pad-mounted transformer to a gang meter center and a main disconnect shall be treated like a commercial service. The customer owns and installs the cable from the transformer to the breaker lugs.**

When the Customer's panel requires parallel service conductors in multiple conduits to support the electrical load, each conduit shall be comprised of a neutral and one conductor tied to each hot bus in the panel.

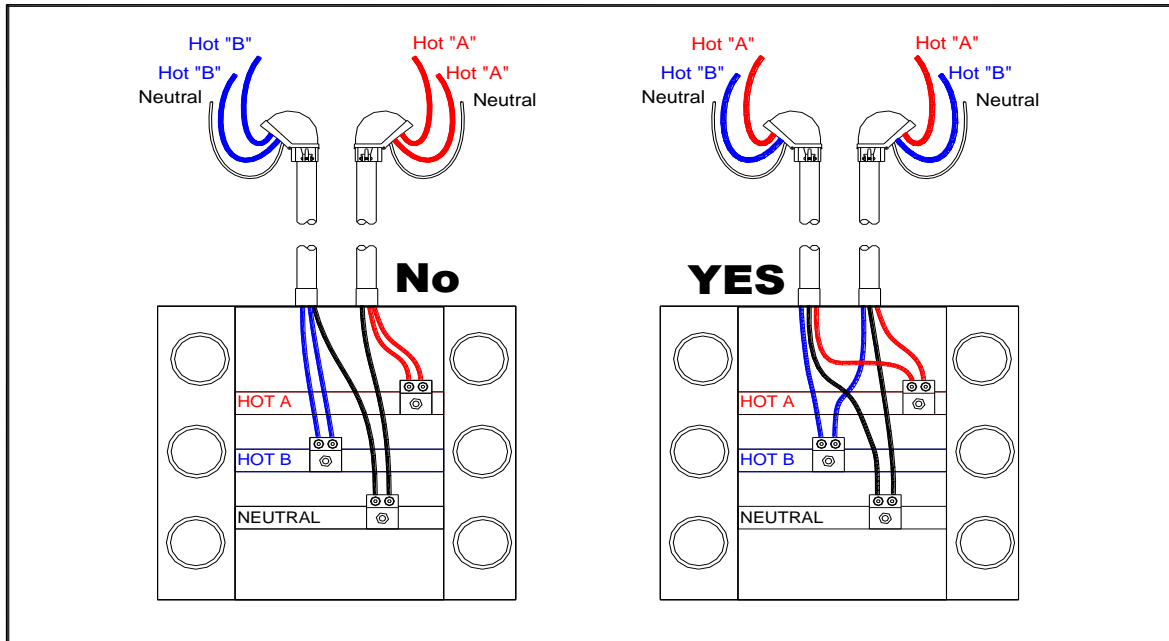

Duplex Metering

Duplex meter bases for overhead service are not allowed (see Figure 36), but is acceptable for underground service if it is approved by the Codes inspector. Triplex meter bases shall not be used on a duplex residential service. Duplex meter bases shall be labeled as described in the drawing notes for Figure 35: Gang Meter Details.

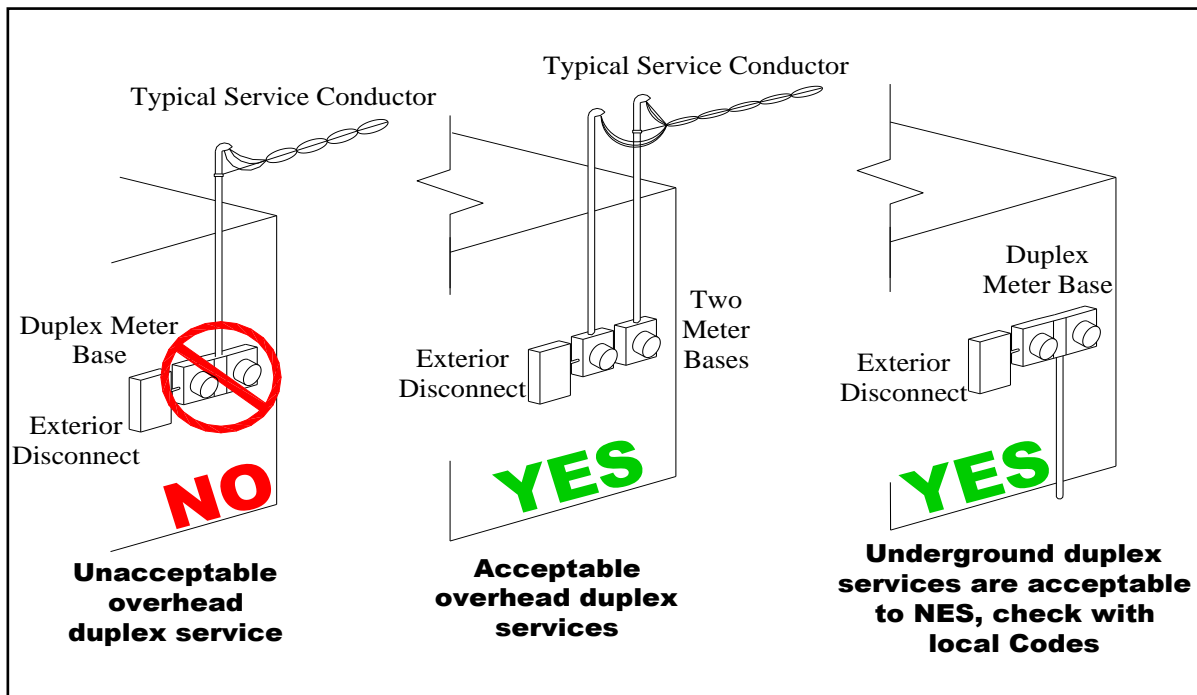

Figure 36: Duplex Metering

A

Electric Service Guidelines

APPENDIX A: LIGHTING

Obtaining Street Lights

NES will maintain the brands and fixture types for poles and luminaires shown in the **NES Street Light Design Manual**. The manual can be viewed on www.nespower.com by clicking the *Builders & Contractors* tab then selecting *Guidelines and Manuals* then select *Street Light Design Manual* (pdf), or contact streetlighting@nespower.com to obtain a copy of the manual.

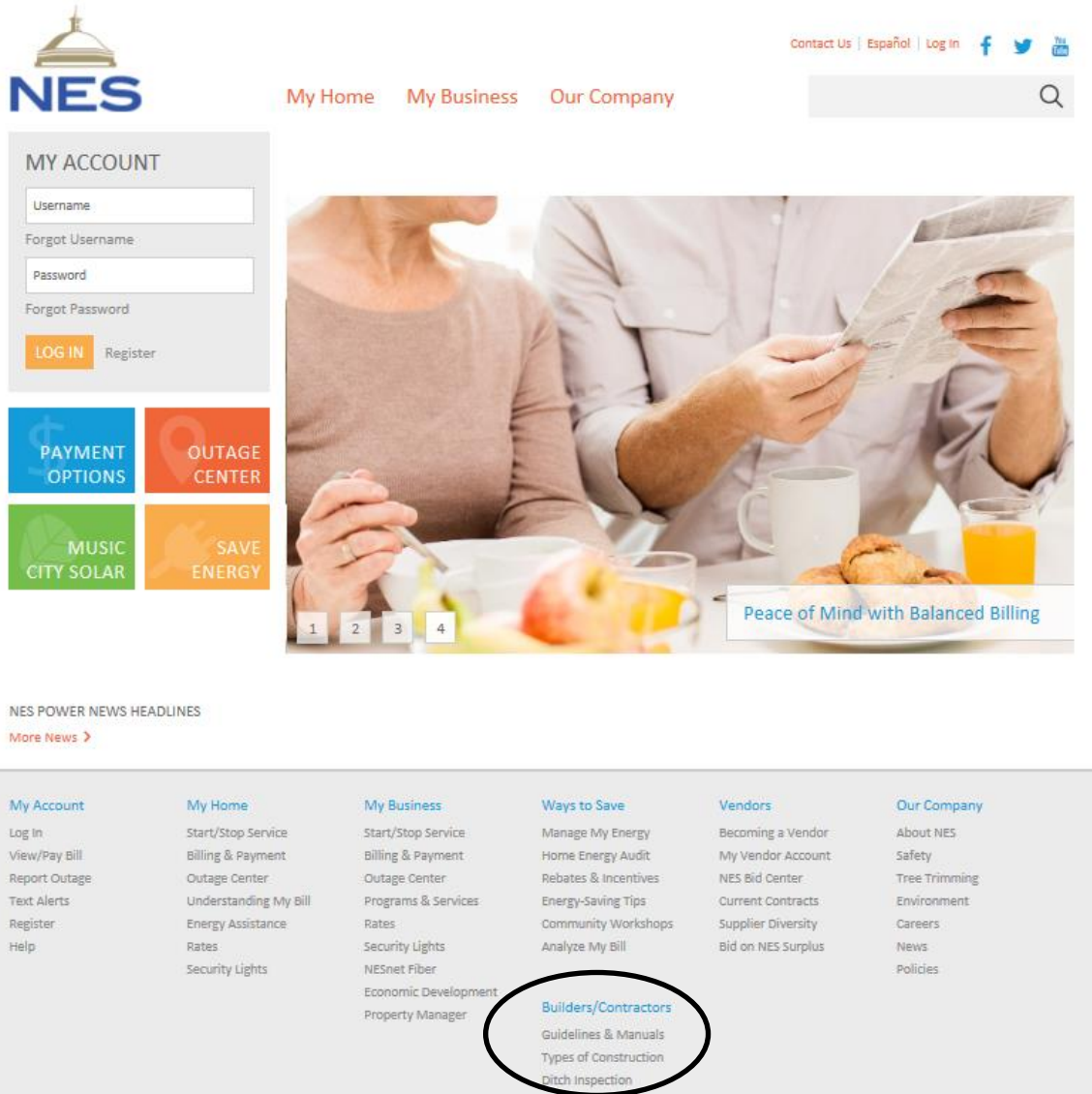

The local Public Works Agency or Home Owners Association shall make a formal request to NES for all new street lighting. NES serves as a “contractor” for Metro and other entities to maintain selected street lights as shown in the Street Light Design Manual. To make a formal request, send a letter stating the quantity and type lights being requested, for example

All written requests for new installations should be directed to the Lighting Supervisor and a copy to the Lighting Engineer. Send written requests to:

Nashville Electric Service
Customer Engineering Section
Street Lighting Group
1214 Church Street, Room 337
Nashville, TN 37246

Once a written request is received, NES will process the contract. The Customer will be assigned a primary contact for the duration of the project. All street lighting applications will be designed in accordance with the most recent edition of the Illuminating Engineering Society (IES) Recommended Practices, or as required by other local jurisdictional requirements.

If a governing agency does not wish to follow the IES Recommended Practices, the written request shall state that understanding. For example: "Thompsonville Public Works requests that NES install 4 - 100 watt Cobrahead lights on poles #01501057, #01501058, #01501064 and #01501068. Thompsonville Public Works understands that this installation may not meet IES recommended practices."

Please note that all state highway lighting shall be approved by the Tennessee Department of Transportation (TDOT), which can take 90 or more days.

Obtaining Private Lights

To obtain private lights, call the Customer Call Center at (615)736-6900. An Energy Services Account Manager will contact the Customer to complete a Rental Outdoor Lighting Contract. NES will normally install outdoor lighting on an existing wood utility pole if the voltage and clearance are available. If a new pole needs to be set, there will be a monthly charge. NES must install outdoor lighting such that NES equipment can be safely operated without damage to the surrounding property. If this is not possible, NES will ask that the Customer sign a "Location of Security Lights Agreement."

APPENDIX B: LEGENDS USED ON NES DRAWING

| EXISTING <i>BLACK</i> | NEW <i>RED</i> | REMOVE <i>GREEN</i> | EXAMPLE NOTATIONS | DESCRIPTIONS |
|--------------------------|-------------------|------------------------|---|---|
| | | | | SECONDARY PULL BOX |
| | | | | PRIMARY PULL BOX |
| | | | <div style="border: 1px solid red; padding: 2px; display: inline-block;"> PMH-9 00000-000-0 FUSE SIZE </div> | PAD MOUNTED SWITCH: PMH-3, PMH-6, PMU-6M, PMH-9, PMH-11, PMH-12, OR PMH-9-AUTO |
| | | | <div style="border: 1px solid red; padding: 2px; display: inline-block;"> PHASE- POLE 00000-000-0 </div> | TERMINATING CABINET: NUMBER OF PHASES AND POLES |
| | | | MH-1 | MANHOLE RECTANGULAR |
| | | | MH-1 | MANHOLE OCTAGONAL |
| | | | <div style="border: 1px solid blue; padding: 2px; display: inline-block;"> UDP1 kVA 000-00-000-0 </div> | 1Ø UGRD TRANSFORMER 14.4/24.9kV to 120/240V PAD # and kVA SIZE |
| | | | <div style="border: 1px solid blue; padding: 2px; display: inline-block;"> UDP10 0000kVA DF 14.4/24.9kV 120/208V 000-00-000-0 FUSE 0 AMPS USE PAD DETAIL USK-0000 </div> | 3Ø UGRD TRANSFORMER PAD #, kVA SIZE PRIM./SEC. VOLTAGES AS NOTED |
| | COLOR BLUE | | | TEMPORARY SERVICE PEDESTAL FOR TEMPORARY UNDERGROUND SERVICES. |
| | | | | GROUND SURGE ARRESTER, STATE VOLTAGE, 12kV OR 18kV |
| | | | | STUB OUT CONDUIT FOR FUTURE SERVICE STANDARD 3" DIAMETER SCH 40 PVC UNLESS OTHERWISE NOTED |
| | | | #1AL, 200' 2-3"-PVC | UNDERGROUND PRIMARY CABLE. STATE CABLE SIZE, LENGTH, NUMBER OF CONDUITS AND THE DIAMETER. |
| | | | | FEED THROUGH BUSHING TO BE INSTALLED ON PAD MOUNTED TRANSFORMERS TO PROVIDE Y SPLICE. |
| | | | | SECONDARY TO A MULTIPLE METER POINT. INDICATE BUILDING NUMBER, WIRE SIZE, CONDUIT SIZE AND LENGTH AND NUMBER OF METERS |
| | | | <div style="border: 1px solid blue; padding: 2px; display: inline-block;"> UDP # ??? - kVA DF 13.8 kV 120/240 V 000-00-000-0 </div> | TURTLE SIDEWALK TRANSFORMER |

Figure 37: Underground Equipment Symbols

| EXISTING <i>BLACK</i> | NEW <i>RED</i> | REMOVE <i>GREEN</i> | TEMP <i>BLUE</i> | EXAMPLE NOTATIONS | DESCRIPTIONS |
|--------------------------|-------------------|------------------------|---------------------|---|---|
| | | | | OPW50-(CLASS) POLE NUMBER R-PW45 | NES TO INSTALL A NEW 50 FOOT TALL CLASS 3 WOOD POLE AND REMOVE A 45 FOOT TALL CLASS 4 POLE |
| | | | | OPC50-(CLASS) POLE NUMBER R-PC50 | NES TO INSTALL A NEW 50 FOOT TALL CONCRETE POLE AND REMOVE A 50 FOOT TALL CONCRETE POLE |
| | | | | OPSS0-(CLASS) POLE NUMBER R-PSS0 | NES TO INSTALL A NEW 50 FOOT TALL STEEL POLE AND REMOVE A 45 FOOT TALL STEEL POLE |
| | | | | BST 50'C-3 POLE NUMBER BST 45'C-4 | SCB TO INSTALL A NEW 50 FOOT TALL TALL CLASS 3 WOOD POLE AND REMOVE A 45 FOOT TALL CLASS 4 POLE |
| | | | | SPECIAL DESIGN INFORMATION ON CONS. DRAWING | STEEL TOWER OWNED BY NES |
| I | I | I ^R | | SPECIAL DESIGN INFORMATION ON CONS. DRAWING | STEEL STUB BY NES |
| | | | | SPECIAL DESIGN INFORMATION ON CONS. DRAWING | STEEL POLE TOWER OWNED BY NES |
| | | | | | LEAD= DISTANCE IN FEET FROM BASE OF POLE TO THE ANCHOR, ANC SIZE= HOLDING CAPACITY OF ANCHOR IN THOUSANDS OF POUNDS, SDWK INDICATES THE USE OF A SIDEWALK BRACE. TEL INDICATES AN ANCHOR INSTALLED BY BELLSOUTH DO NOT INSTALL NES GUYS IN CABLE TV ANCHORS |
| | | | | | |
| | | | | | |
| | | | | | ADD OR REMOVE A GUY FROM AN EXISTING ANCHOR. |

Figure 38: Pole and Anchor Symbols

A

Electric Service Guidelines

| EXISTING <i>BLACK</i> | NEW <i>RED</i> | REMOVE <i>GREEN</i> | TEMP <i>BLUE</i> | EXAMPLE NOTATIONS | DESCRIPTIONS |
|--------------------------|-------------------|------------------------|---------------------|--|--|
| | | | | <i>1-25kVA R-25kVA</i> | 1Ø OVHD TRANSFORMER KVA SIZE |
| | | | | <i>1-112.5kVA 125/216V</i> | 3Ø OVHD TRANSFORMER KVA SIZE & SECONDARY VOLTAGE |
| | | | | <i>1-3-100kVA 277/480V</i> | 3Ø OVHD BANK XMFR'S KVA SIZE & SECONDARY VOLTAGE OF EACH UNIT |
| | | | | SEE THE SWITCH SECTION OF THE PLATE BOOK | SWITCH OVHD, INDICATE SIZE, ABS OR LBS, SWITCH #, POLE #. AND OPEN OR CLOSED STATUS |
| | | | | SEE THE SWITCH SECTION OF THE PLATE BOOK | DISCONNECT SHOW FUSE SIZE |
| | | | | SEE THE SWITCH SECTION OF THE PLATE BOOK | DISCONNECT WITH BLADES SHOW # OF BLADES |
| | | | | SEE THE SWITCH SECTION OF THE PLATE BOOK | ELECTRONIC SECTIONALIZER SHOW AMPS AND # OF SHOTS |
| | | | | SEE THE SWITCH SECTION OF THE PLATE BOOK | OIL SWITCH OR RECLOSER |
| | | | | SEE THE SWITCH SECTION OF THE PLATE BOOK | STATE SWITCH SIZE AND ADD ANTENNA SYMBOL IF REMOTE OPERATION IS REQUIRED |
| | | | | SEE THE SWITCH SECTION OF THE PLATE BOOK | IN-LINE DISCONNECT SWITCH: STATE SWITCH SIZE: 900A OR 1200A |
| | | | | SEE THE SWITCH SECTION OF THE PLATE BOOK | LINE TAP DISCONNECT SWITCH 900A ONLY |
| | | | | <i>1-ANTENNA Ø 42' MINIMUM</i> | ANTENNA SYMBOL FOR A REMOTELY OPERATED SWITCH |
| | | | | | <u>DURABUTE "GE" DO NOT INSTALL</u> |
| | | | | <i>1-3-18kV SUR. ARR.</i> | ARRESTER, SURGE 18kV, 12kV & 3kV |
| | | | | <i>1-3-200kVAR CAP.</i> | CAPACITOR BANK DESIGNATE NES OR TVA |
| | | | | <i>1-PM-(1, 2 OR 3)</i> | METERED PRIMARY LINE |

Figure 39: Overhead Equipment Symbols

| EXISTING BLACK | NEW RED | REMOVE GREEN | TEMP BLUE | FUTURE MAGENTA | EXAMPLE NOTATIONS | DESCRIPTIONS |
|-------------------|------------|-----------------|--------------|-------------------|---|--|
| | | | | | SL/6/250 | STREET LIGHT / MASTARM LENGTH / WATTAGE |
| | | | | | LSTAND/AL/27 POLE NUMBER SL/8/150 | STREET LIGHT & MASTARM MTD ON ALUMINUM POLE |
| | | | | | LPW35 POLE NUMBER P400/2 | PRIVATE LIGHT & MASTARM MOUNTED ON WOOD POLE |
| | | | | | INSTALLED BY OTHERS MAINTAINED BY NES | HIGH MAST INTERSTATE LIGHT |
| | | | | | | MONGOOSE |
| | | | | | LSTD-HADCO-16 POLE NUMBER L15HPS-H/ACORN/BL/V | DECORATIVE |
| | N/A | | | N/A | | OFFSET |
| | | | | | | FLOOD |
| | | | | | | HIGH MAST |
| | | | | | | WALL PACK |
| | | | | | | SHOE BOX |
| | | | | | | CONTROL STATION |
| | | | | | | DISCONNECT |
| | | | | | | |
| | | | | | | |

Figure 40: Lighting Symbols

A

Electric Service Guidelines













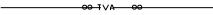





| SYMBOL | DESCRIPTIONS |
|---|--|
|  | <i>CUSTOMER POLE</i> |
|  | <i>TVA STEEL TOWER</i> |
|  | <i>TVA TRANSMISSION LINE, USED WHERE ROW IS UNKNOWN</i> |
|  | <i>FENCE LINE</i> |
|  | <i>PROPERTY LINE</i> |
|  | <i>RIGHT-OF-WAY LINE</i> |
|  | <i>RAILROAD - SINGLE TRACK</i> |
|  | <i>RAILROAD - DOUBLE TRACK</i> |
|  | <i>STREET BOUNDARIES</i> |
|  | <i>WATER LINES</i> |
|  | <i>SEWER LINES</i> |
|  | <i>UNDERGROUND COMMUNICATIONS</i> |
|  | <i>GAS LINES</i> |
|  | <i>TRIM TREES TO CLEAR LINES, STATE IF PERMISSION WAS OBTAINED ALONG WITH THE PROPERTY OWNER'S NAME AND TELEPHONE NUMBER</i> |
|  | <i>NORTH ARROW</i> |
|  | <i>FUTURE NES FACILITIES. DRAW THE APPROPRIATE SYMBOL USING THE LINE TYPE AND FUTURE EQUIPMENT AUTOCAD LAYER.</i> |
|  | <i>TRAFFIC AND PARKING SIGNAL POLE</i> |
|  | <i>ROADWAY SIGNAGE AND BILLBOARDS</i> |
| | |

Figure 41: Base Map Symbols

APPENDIX C: SAFETY CLEARANCES

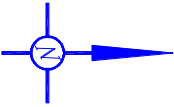
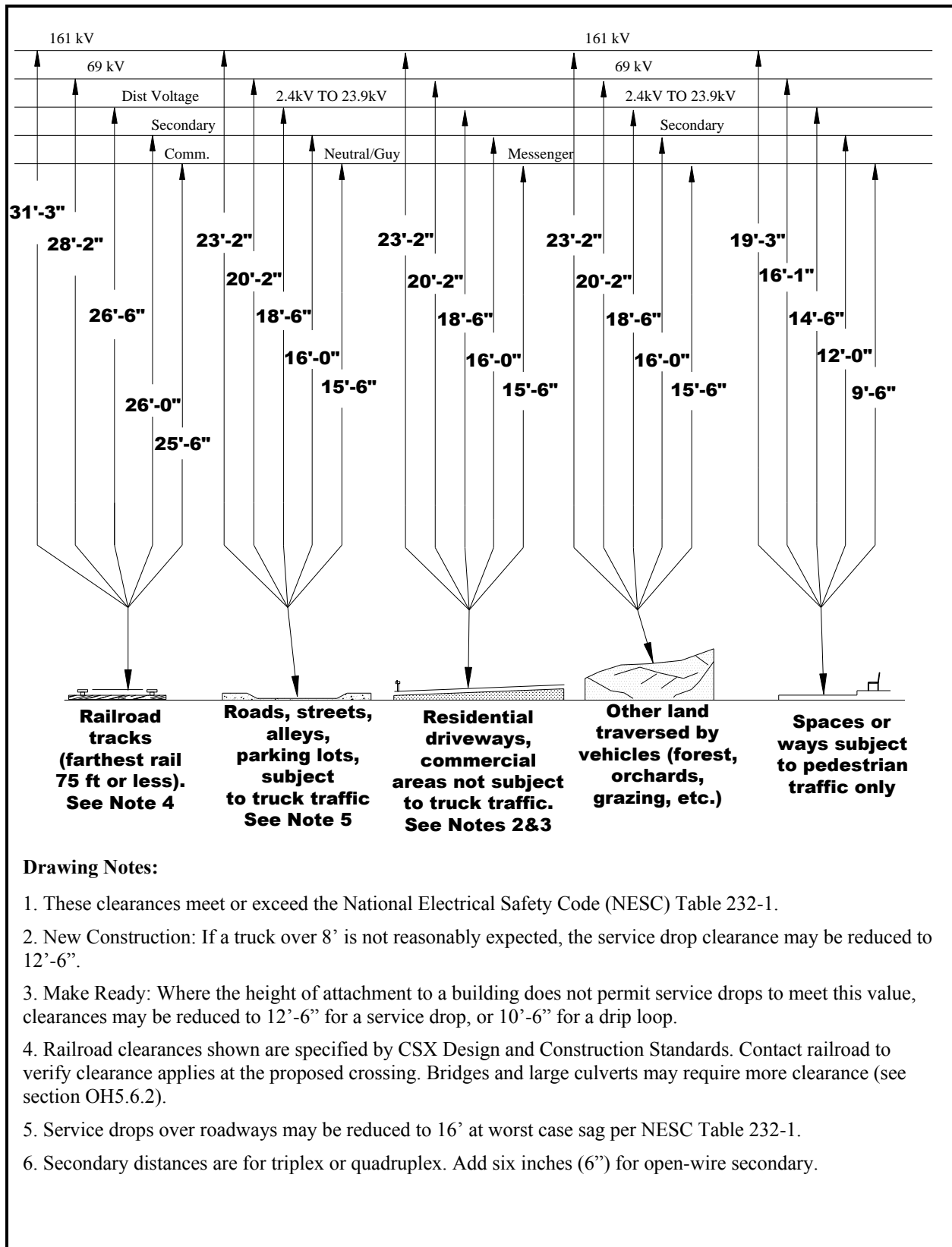
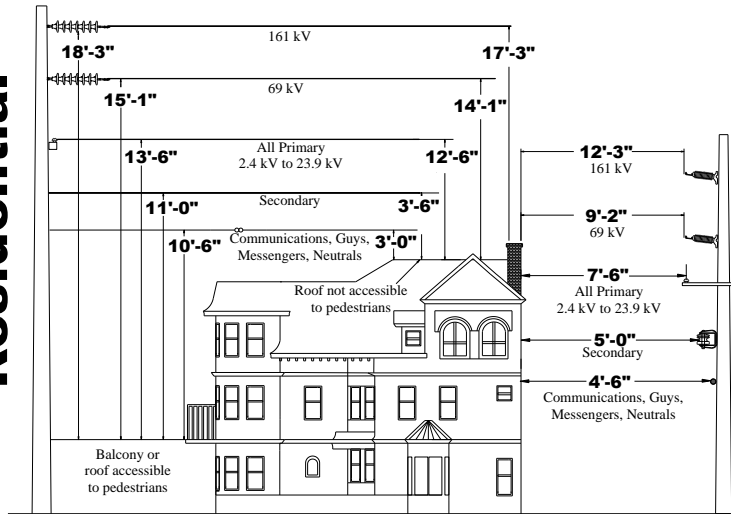

Figure 42: Vertical Clearances

A

Electric Service Guidelines

Residential



Commercial

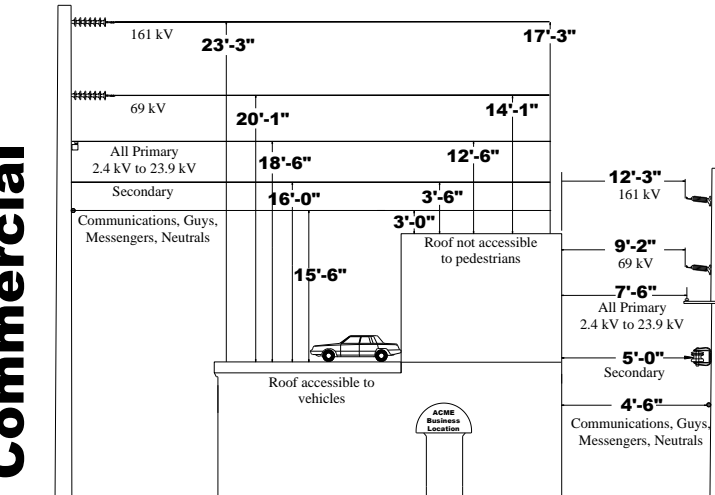

for open-wire secondary.

Drawing Notes:

1. These clearances meet or exceed the National Electrical Safety Code (NESC), Table 234-1.
2. Clearances for transmission lines include a three foot (3') blow-out allowance. Conductors on suspension insulators may require additional clearance. Clearance is a function of span length and sag at 60° F. Refer to section 5.1.7 for more details.
3. Pedestrian access applies if the roof can be reached by ramp, stairway, doorway or permanent ladder.
4. Vehicle clearances apply if vehicles which are eight feet or greater in height are allowed.
5. Secondary distances are for triplex or quadruplex. Add six inches (6")

Figure 43: Building Clearances

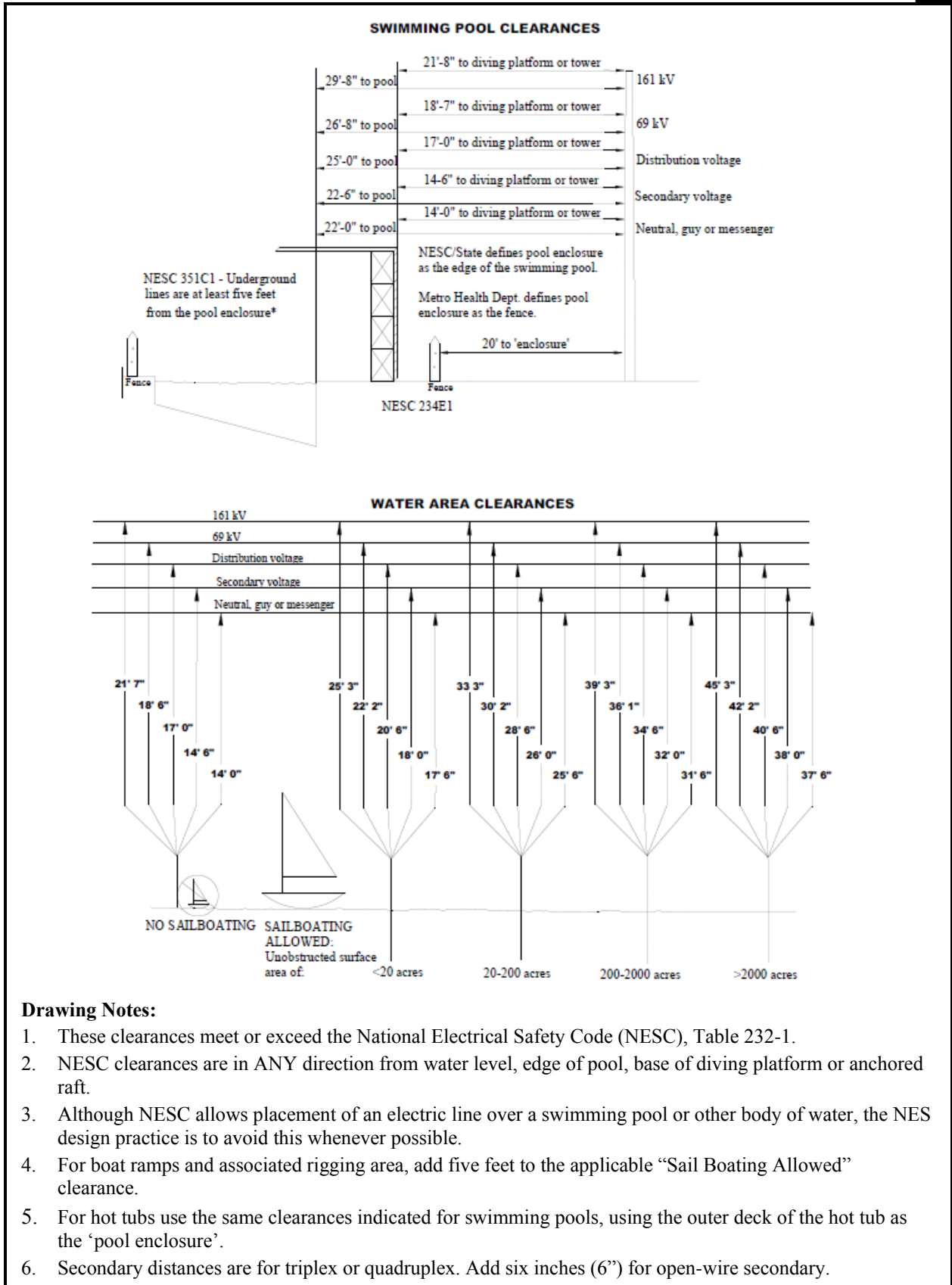

Drawing Notes:

1. These clearances meet or exceed the National Electrical Safety Code (NEC), Table 232-1.
2. NEC clearances are in ANY direction from water level, edge of pool, base of diving platform or anchored raft.
3. Although NEC allows placement of an electric line over a swimming pool or other body of water, the NEC design practice is to avoid this whenever possible.
4. For boat ramps and associated rigging area, add five feet to the applicable "Sail Boating Allowed" clearance.
5. For hot tubs use the same clearances indicated for swimming pools, using the outer deck of the hot tub as the 'pool enclosure'.
6. Secondary distances are for triplex or quadruplex. Add six inches (6") for open-wire secondary.

Figure 44: Swimming Pool and Waterways Clearances

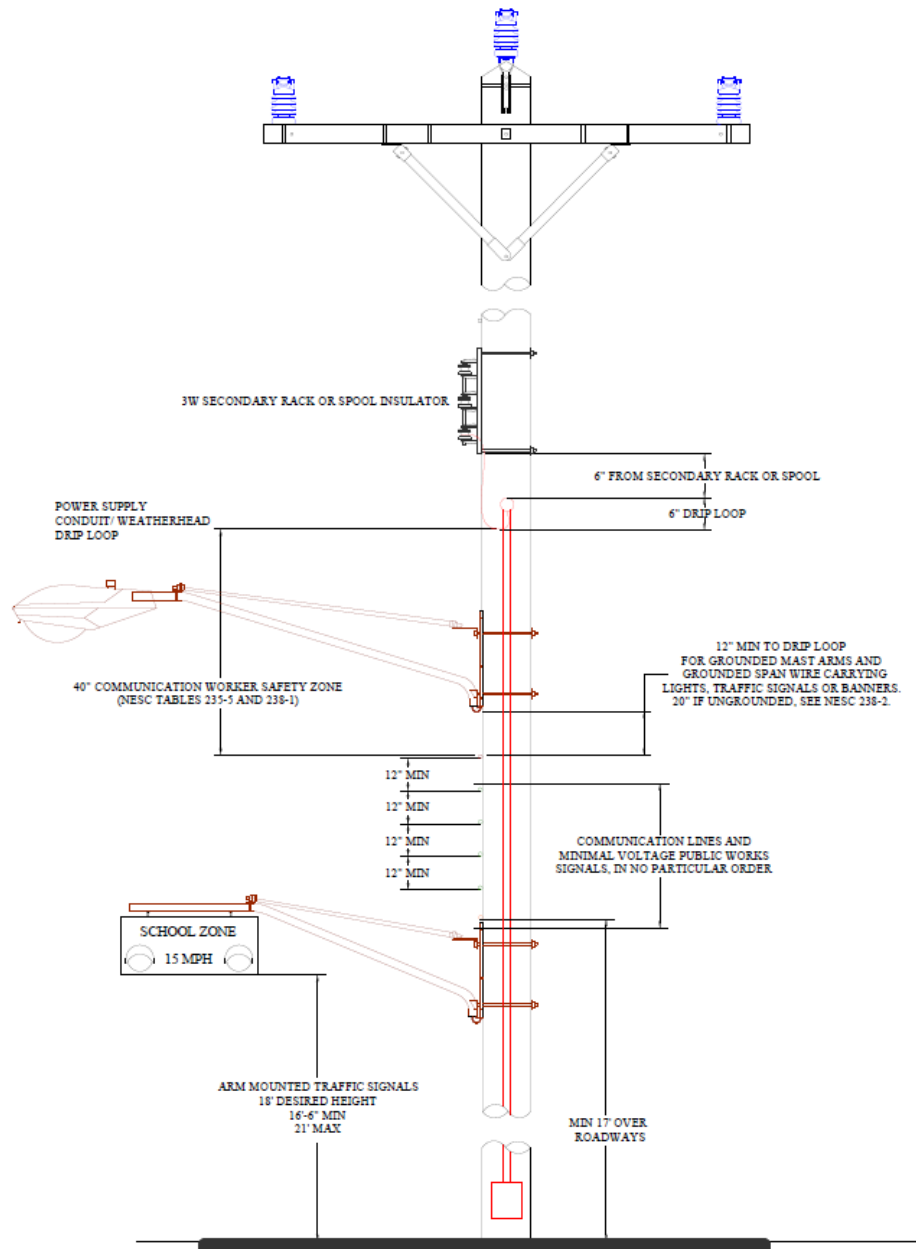
**Drawing Notes:**

1. These clearances meet or exceed the National Electrical Safety Code (NESC), applicable rule appears on drawing.
2. These distances are minimums. NESC Rule 235 H requires clearances between lines of different communication companies to be at least four inches (4") anywhere in the span. NESC Rule 235H also requires spacing between messengers supporting communications cables to be at least 12 inches. This may necessitate spacing at the pole greater than the NESC minimum shown.

Figure 45: Communications Clearances

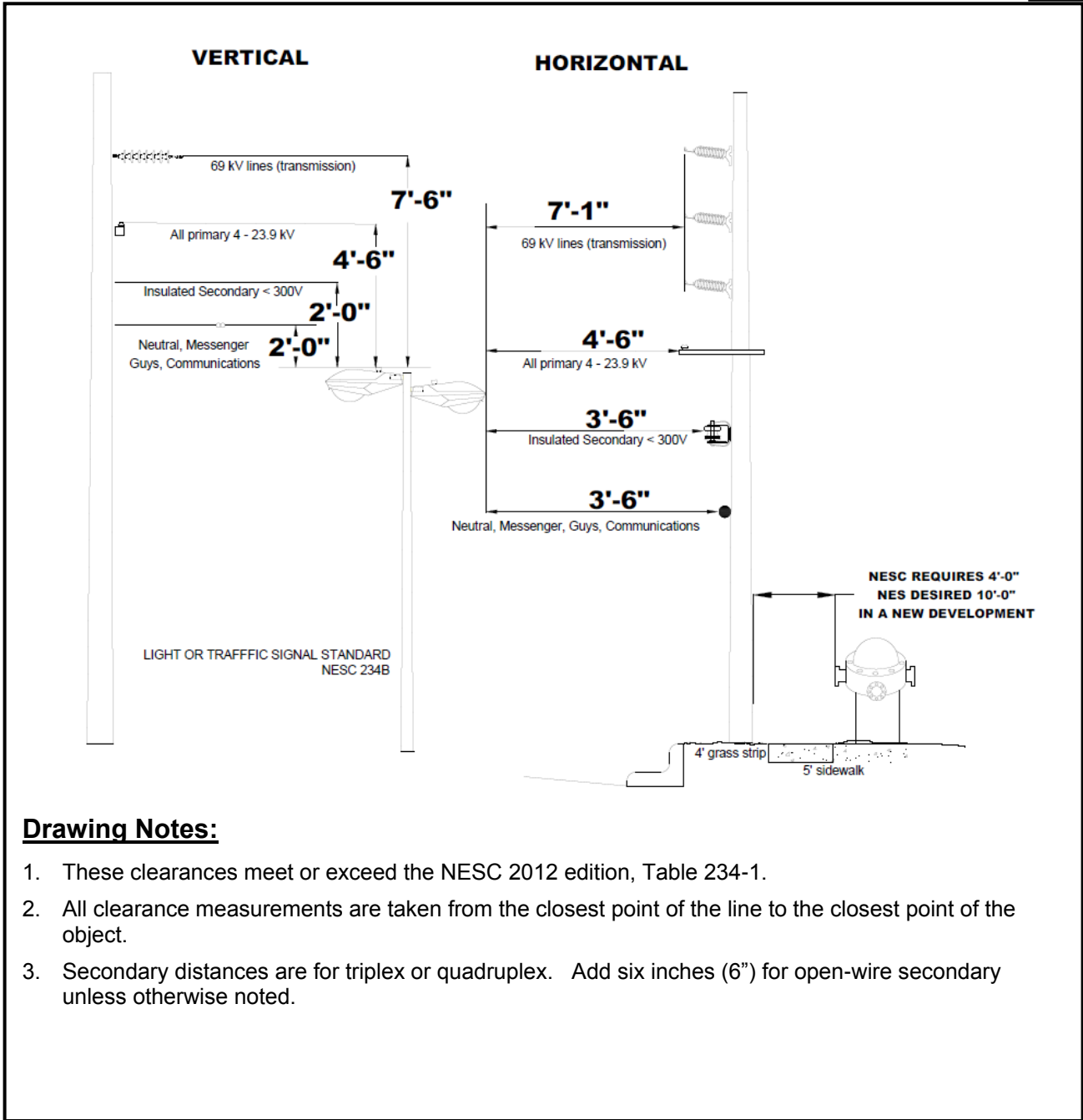

Drawing Notes:

1. These clearances meet or exceed the NESC 2012 edition, Table 234-1.
2. All clearance measurements are taken from the closest point of the line to the closest point of the object.
3. Secondary distances are for triplex or quadruplex. Add six inches (6") for open-wire secondary unless otherwise noted.

Figure 46: Street Light Fixture & Fire Hydrant Clearances

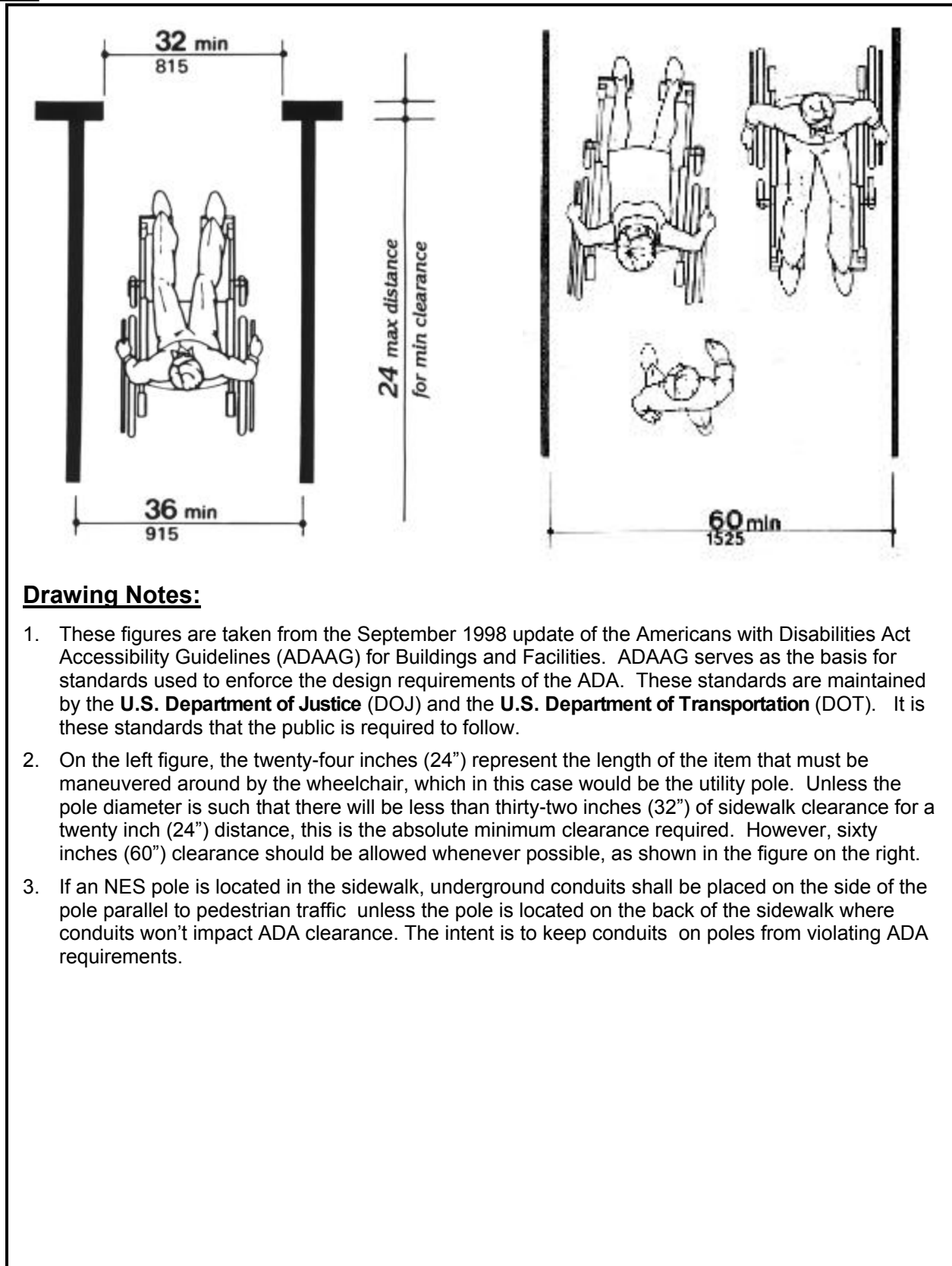

Drawing Notes:

1. These figures are taken from the September 1998 update of the Americans with Disabilities Act Accessibility Guidelines (ADAAG) for Buildings and Facilities. ADAAG serves as the basis for standards used to enforce the design requirements of the ADA. These standards are maintained by the **U.S. Department of Justice (DOJ)** and the **U.S. Department of Transportation (DOT)**. It is these standards that the public is required to follow.
2. On the left figure, the twenty-four inches (24") represent the length of the item that must be maneuvered around by the wheelchair, which in this case would be the utility pole. Unless the pole diameter is such that there will be less than thirty-two inches (32") of sidewalk clearance for a twenty inch (24") distance, this is the absolute minimum clearance required. However, sixty inches (60") clearance should be allowed whenever possible, as shown in the figure on the right.
3. If an NES pole is located in the sidewalk, underground conduits shall be placed on the side of the pole parallel to pedestrian traffic unless the pole is located on the back of the sidewalk where conduits won't impact ADA clearance. The intent is to keep conduits on poles from violating ADA requirements.

Figure 47: ADA Sidewalk Clearances

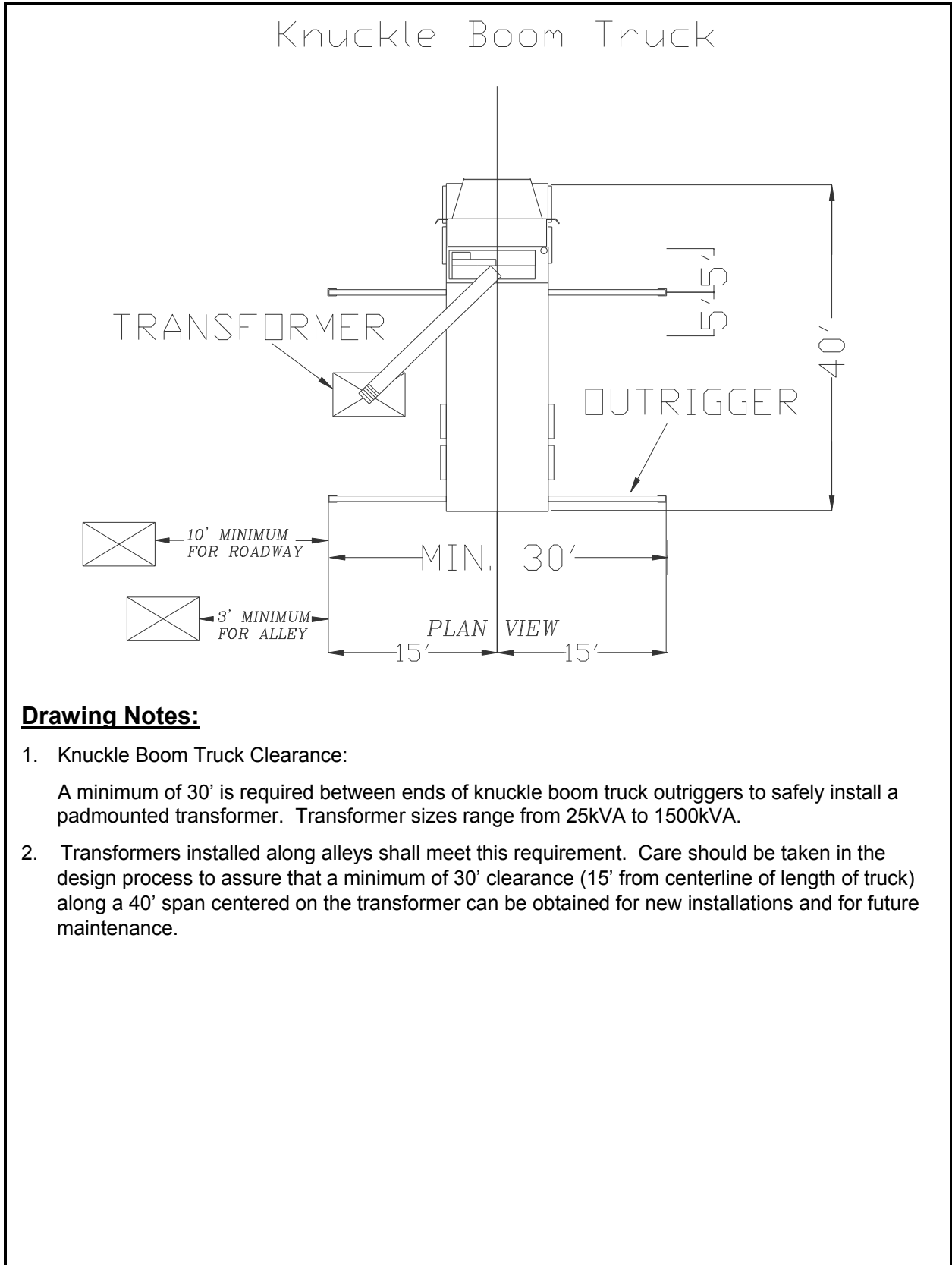
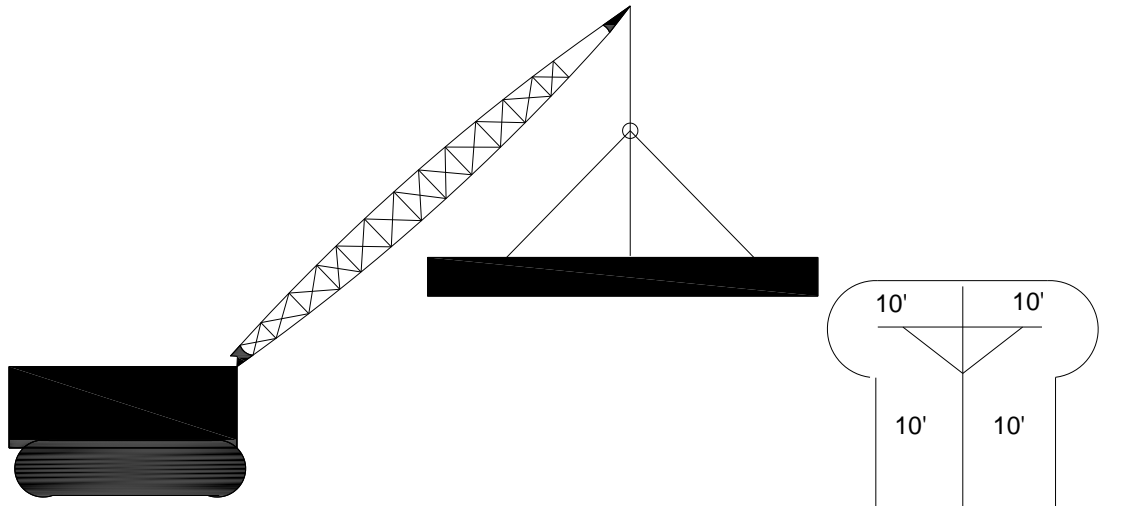

Figure 48: Transformer Installation - Knuckle Boom Truck Clearance



1. Keep all vehicles and heavy machinery – cranes, bucket and dump trucks, backhoes, front-end loaders, cement pumpers, etc. out of the danger zone around distribution lines (a minimum of 10 feet) as required by OSHA and TOSHA (see OSHA STD. 1926.1408). Any exception to these clearances must be approved by TOSHA/OSHA and NES Safety (615) 747-3616.
2. **Transmission lines require an even greater distance.**
3. Contact Energy Services @ (615) 747-3775 for assistance concerning clearance issues.

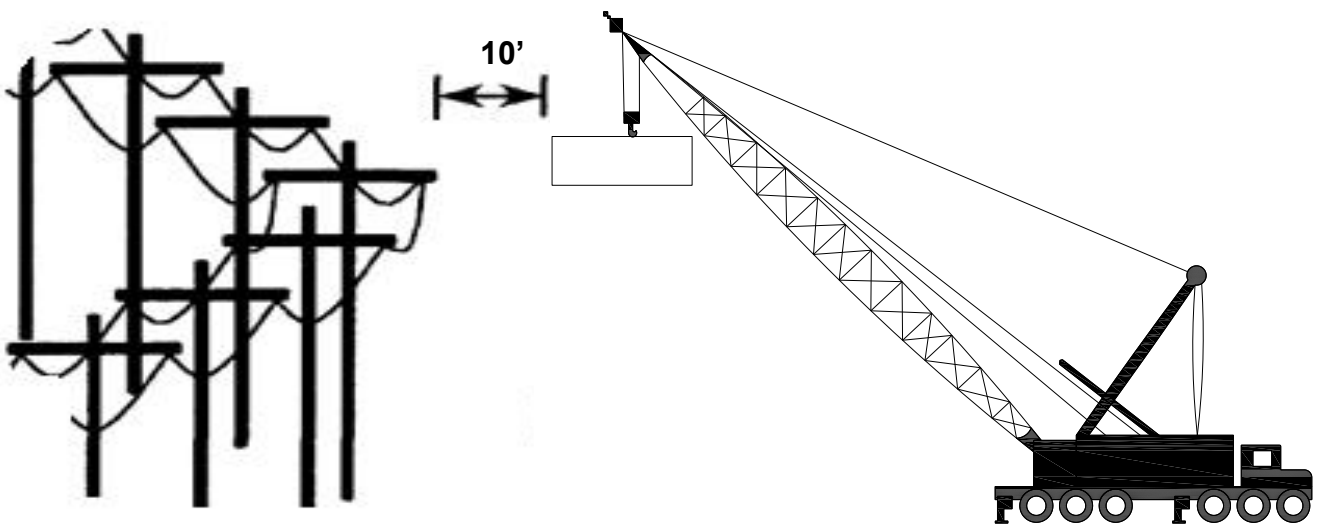
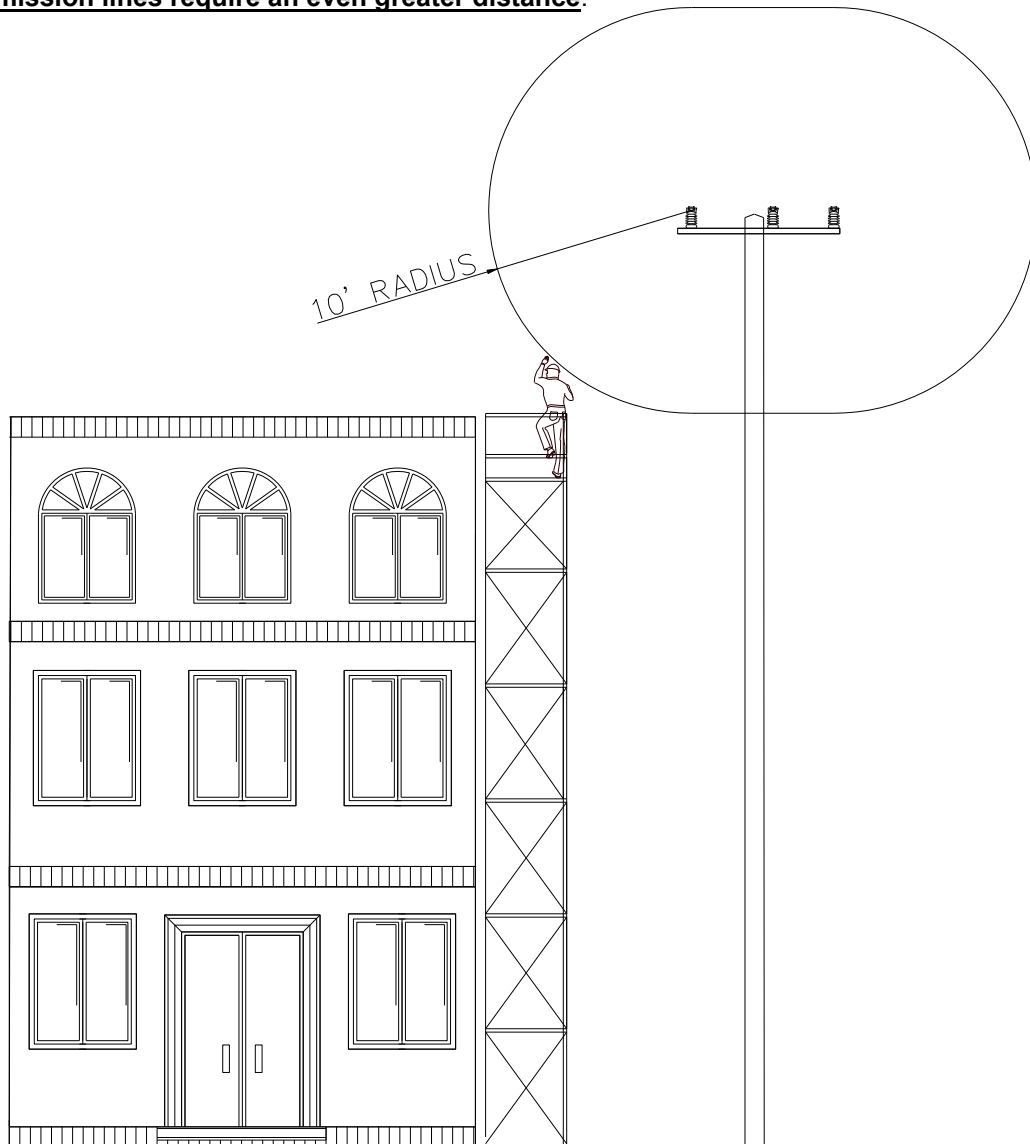

Figure 49: Crane/Elevated Equipment Clearances

Drawing Notes:

1. Construction and maintenance considerations should include any equipment required, such as scaffolds.
2. Minimum of working clearances from energized lines and equipment are required by OSHA and TOSHA (see OSHA STD 1926.451). Minimum distance includes scaffolding and any conductive material handled on the scaffold. Any exception to these clearances must be approved by TOSHA/OSHA and NES Safety (615) 747-3616.
3. **Contact Energy Services @ (615) 747-3775 for assistance concerning clearance issues.**
4. **Transmission lines require an even greater distance.**

**Figure 50: OSHA and TOSHA Working Clearances**

A

Electric Service Guidelines

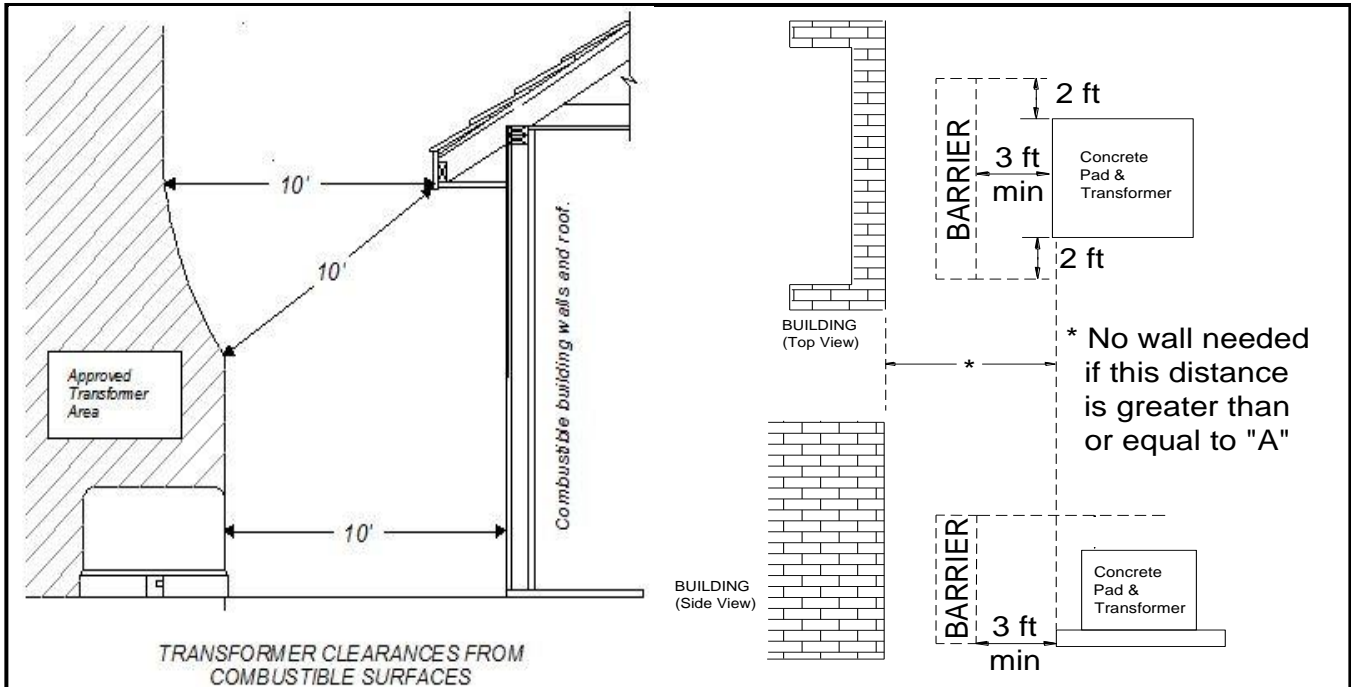

Drawing Notes:

- The fire barrier guidelines apply to all three-phase pad-mounted equipment.
- Transformer pads SHALL NOT be installed, under any circumstances, less than three feet (3') from a building or any other structure. Transformers installed less than the distance indicated as "A" shall have a fire barrier wall installed between the transformer and the building.
- The barrier shall be constructed of non-combustible material so it will Transformer Pad may be installed closer to the building than shown above as distance "A" if the following conditions are fully satisfied:
 - There is no exposure to combustible eaves or trim.
 - The exposed wall construction shall qualify as a 4-hour fire wall (solid concrete block, reinforced concrete, steel, or eight inch (8") brick).
 - Any opening in the exposed wall at the same level as the transformer within the separation distance required (above) shall be protected with approved fire doors.
 - Transformer doors must face away from adjacent walls, including screen walls.

| TRANSFORMER SIZE | "A" DISTANCE | MINIMUM WALL DIMENSIONS |
|------------------|--------------|--|
| 0-75 KVA | 10 FEET | 8 FT WIDE X 7 FT TALL FROM TOP OF PAD |
| 76-333 KVA | 20 FEET | 8 FT WIDE X 7 FT TALL FROM TOP OF PAD |
| OVER 333 KVA | 30 FEET | 10 FT WIDE X 7 FT TALL FROM TOP OF PAD |

Figure 51: Fire Barrier Wall

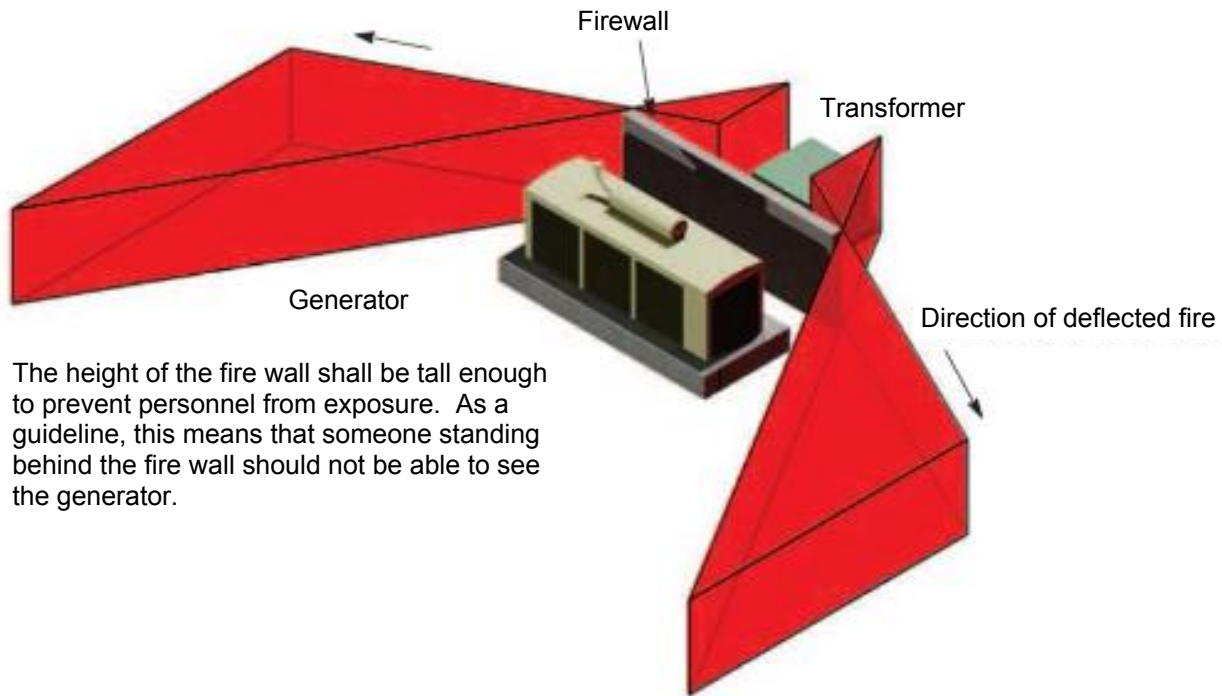

The height of the fire wall shall be tall enough to prevent personnel from exposure. As a guideline, this means that someone standing behind the fire wall should not be able to see the generator.

Drawing Notes:

1. A minimum of twenty feet (20') of clearance is required between transformers and any fuel sources ie; generator fuel tanks, propane tanks, gas meters etc. The clearance may be reduced to 3' if an appropriate firewall is built between the transformer and the fuel source. In all cases, generator exhaust shall be directed away from direction of transformer and be at least 30' higher than the transformer pad.
2. The firewall shall be constructed of non-combustible material so it will qualify as a 4-hour fire wall (solid concrete block, reinforced concrete, steel, or eight inch (8") brick).
3. The height and width of the firewall shall meet ALL of the following requirements:
 - A. Meet the minimum dimensions on page 100.
 - B. Be at minimum two feet (2') taller than the tank of the generator.
 - C. Extend two feet (2') beyond the generator pad on each side.

Figure 52: Fire Barrier Wall

A

Electric Service Guidelines

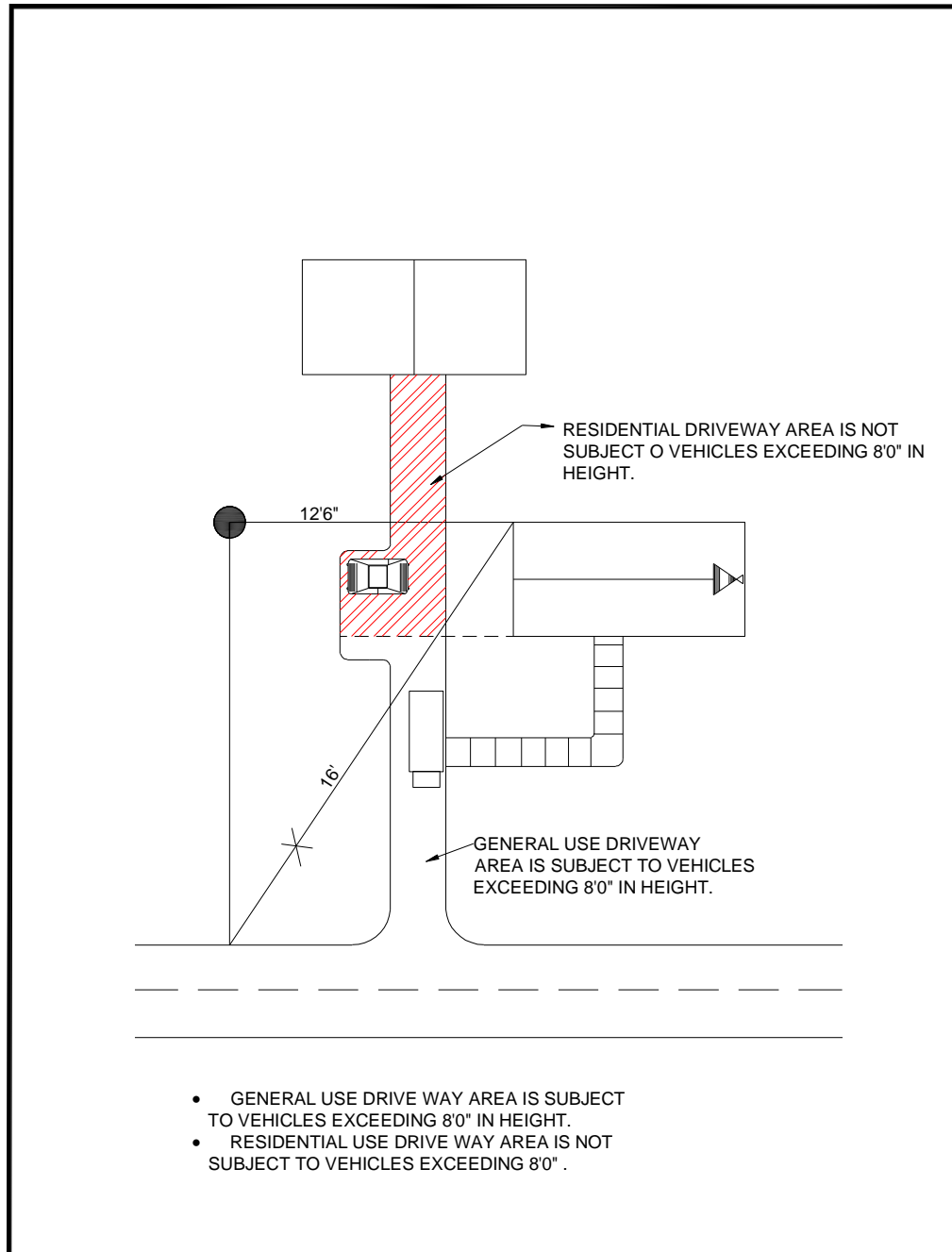

Drawing Notes:

1. Residential driveway exception allows for 12ft service heights crossing the driveway if no there are no vehicles taller than eight (8) feet expected.
2. Consider customer's future plans for the property when designing these jobs.

Figure 53: Driveway Clearances



Intentionally Blank

APPENDIX D: ADDITIONAL INFORMATION

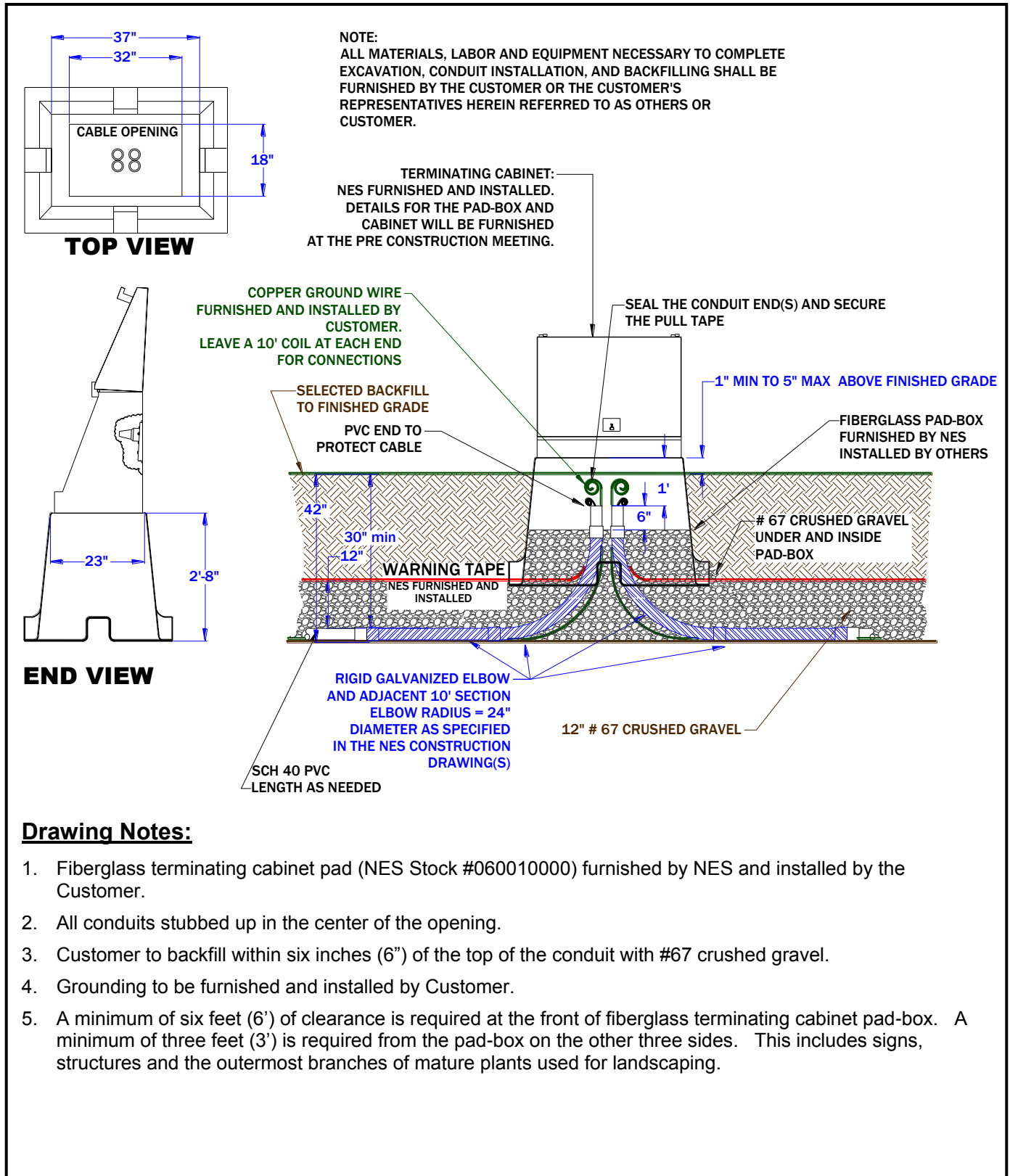

Drawing Notes:

1. Fiberglass terminating cabinet pad (NES Stock #060010000) furnished by NES and installed by the Customer.
2. All conduits stubbed up in the center of the opening.
3. Customer to backfill within six inches (6") of the top of the conduit with #67 crushed gravel.
4. Grounding to be furnished and installed by Customer.
5. A minimum of six feet (6') of clearance is required at the front of fiberglass terminating cabinet pad-box. A minimum of three feet (3') is required from the pad-box on the other three sides. This includes signs, structures and the outermost branches of mature plants used for landscaping.

Figure 54: Pad for Single-phase Primary Terminating Cabinet

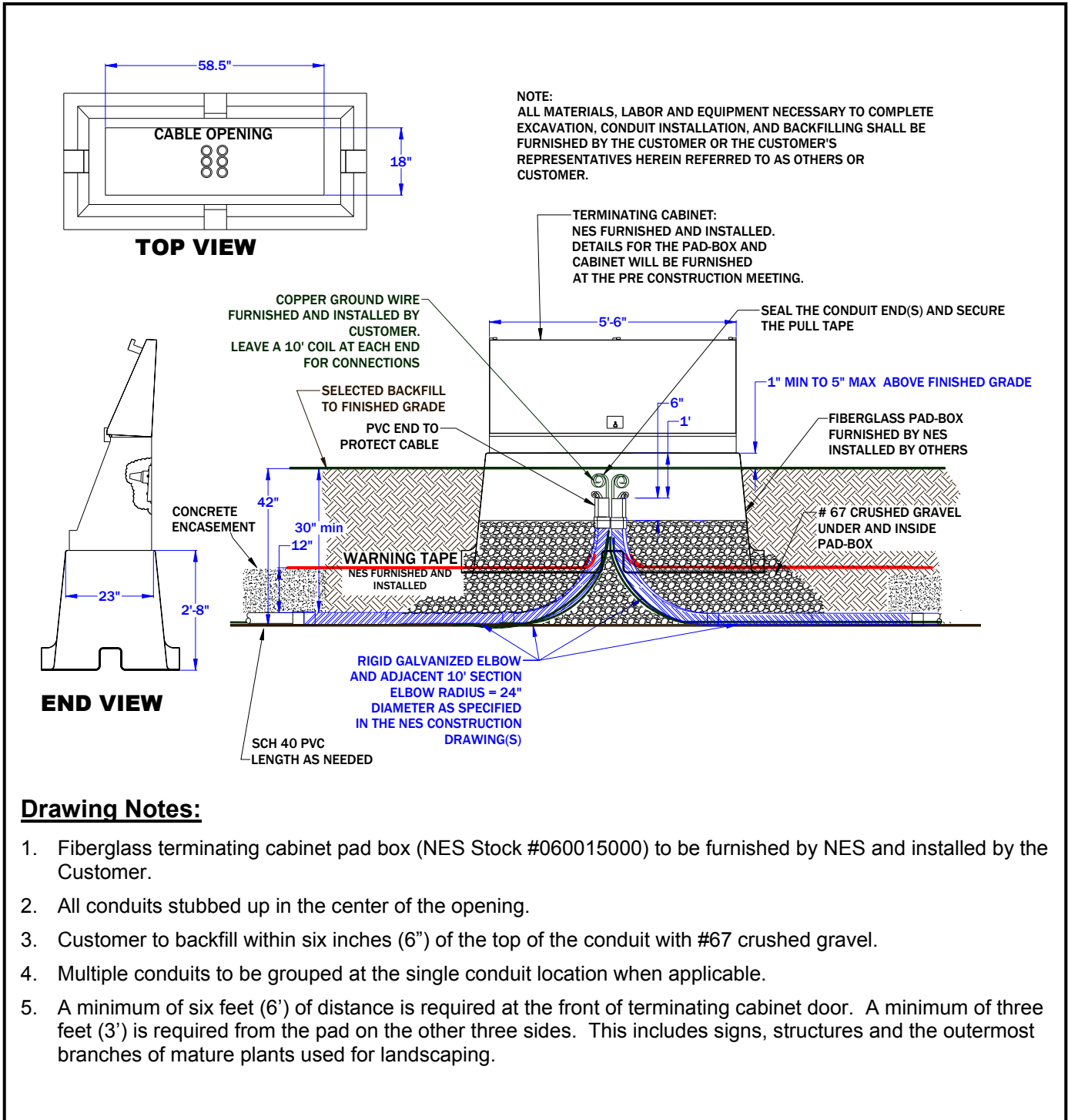

Drawing Notes:

1. Fiberglass terminating cabinet pad box (NES Stock #060015000) to be furnished by NES and installed by the Customer.
2. All conduits stubbed up in the center of the opening.
3. Customer to backfill within six inches (6") of the top of the conduit with #67 crushed gravel.
4. Multiple conduits to be grouped at the single conduit location when applicable.
5. A minimum of six feet (6') of distance is required at the front of terminating cabinet door. A minimum of three feet (3') is required from the pad on the other three sides. This includes signs, structures and the outermost branches of mature plants used for landscaping.

Figure 55: Pad for Three-phase Primary Terminating Cabinet

DITCH INSTALLATION PROCESS

1. EXCAVATE DITCH
2. INSTALL CONDUIT
3. GO TO <https://www.nespower.com/DitchInspection.aspx> TO REQUEST INSPECTION.
4. BACKFILL 12" WITH #67 CRUSHED GRAVEL
5. REQUEST INSPECTION ONLINE (SEE ABOVE).
6. AFTER WARNING TAPE IS INSTALLED, BACKFILL TO FINISHED GRADE.

NOTE:
ALL MATERIALS, LABOR AND EQUIPMENT NECESSARY TO COMPLETE EXCAVATION, CONDUIT INSTALLATION, AND BACKFILLING SHALL BE FURNISHED BY THE CUSTOMER OR THE CUSTOMER'S REPRESENTATIVE(S) HEREIN REFERRED TO AS OTHERS OR CUSTOMER.

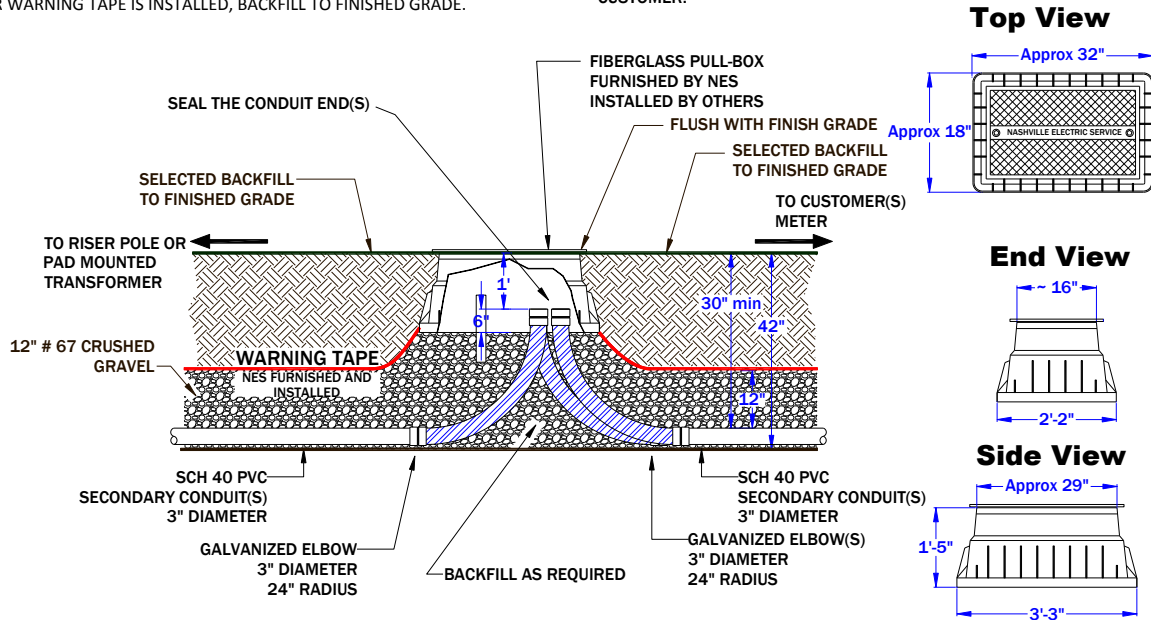

Drawing Notes:

1. Maximum number of permanent service conduits is five (5), including the feeder conduit from riser pole to pull box. Conduits are three inch (3") diameter, unless specified otherwise on the design drawing. Additionally, there can be a three inch (3") temporary conduit, and a two-inch (2") street lighting conduit installed in the pull box.
2. Fiberglass pull box (NES Stock #060034000) is furnished by NES and installed by the Customer.
3. Appropriate backfill as required by NES.
4. Final grade shall be within one inch (1") of the top of the fiberglass pull box.
5. A minimum of three feet (3') of clearance is required all around the pull box cover. This includes signs, structures and the outermost branches of mature plants used for landscaping.
6. **This installation may be used for commercial applications at NES discretion.**
7. **This installation is not to be used in the Downtown Network area.**

Figure 56: Secondary Pull Box For New Subdivision Sidewalk Installations

NOTE:
ALL MATERIALS, LABOR AND EQUIPMENT NECESSARY TO COMPLETE EXCAVATION, CONDUIT INSTALLATION, AND BACKFILLING SHALL BE FURNISHED BY THE CUSTOMER OR THE CUSTOMER'S REPRESENTATIVES HEREIN REFERRED TO AS OTHERS OR CUSTOMER.

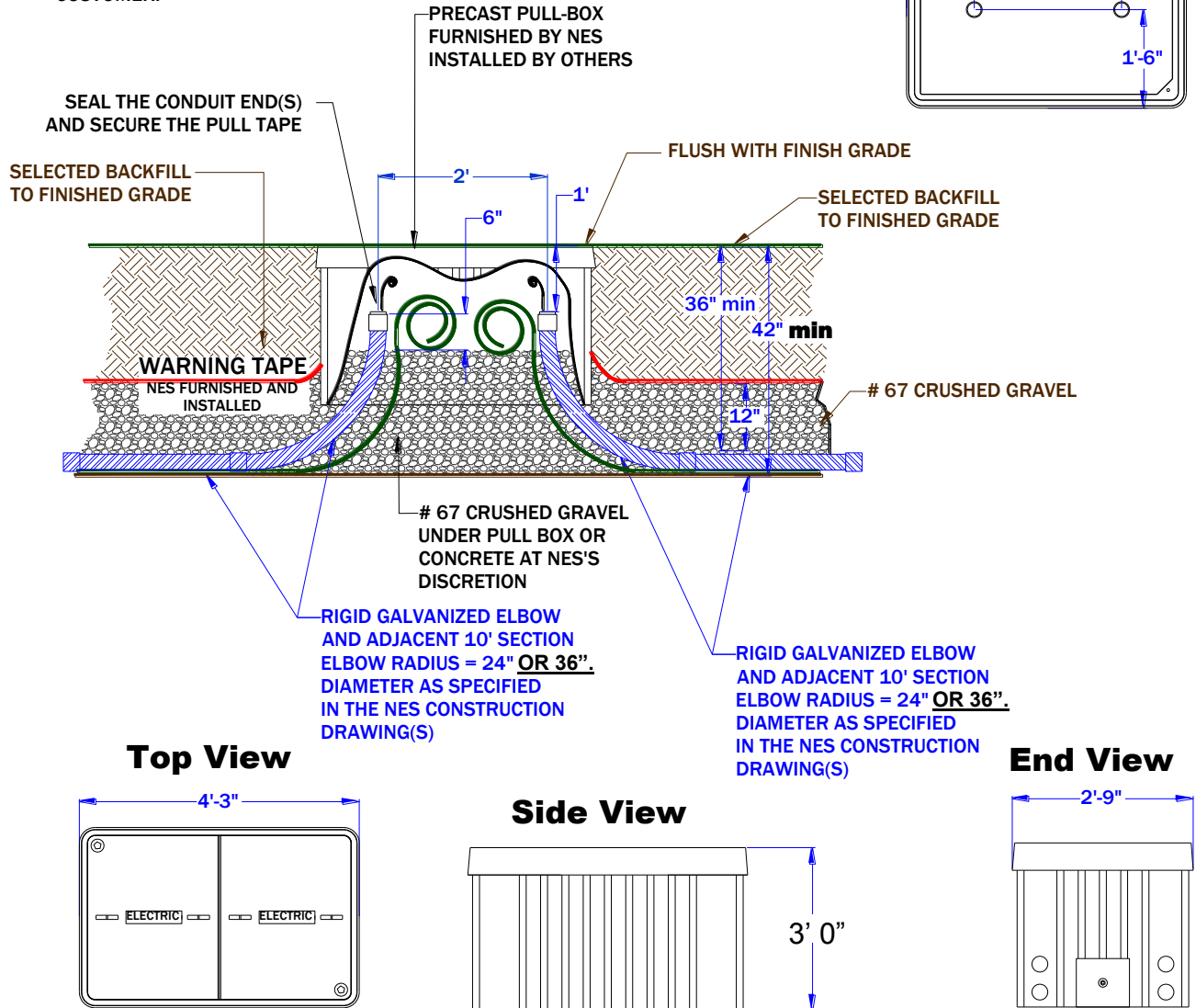

Drawing Notes:

1. This is a non traffic area rated pull box furnished by NES (NES Stock #060044000) and installed by the Customer. Traffic rated pull boxes may be required at NES engineer discretion, and will be supplied by customer.
2. Customer to backfill inside box within six inches (6") of the top of the conduit with #67 crushed gravel.
3. Final grade shall be within one inch (1") of the top of the pull box.
4. A minimum of three feet (3') of clearance is required all around the pull box cover. This includes signs, structures and the outermost branches of mature plants used for landscaping.
5. **This installation is not to be used in the Downtown Network area.**

Figure 57: Primary Pull Boxes

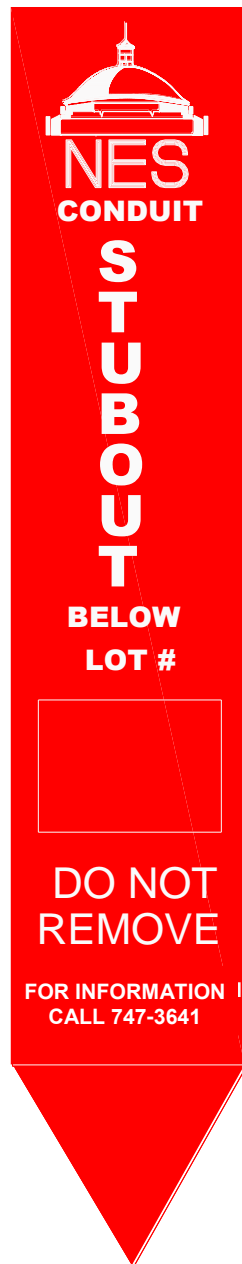
**Drawing Notes:**

1. NES will provide these markers (NES Stock #465337000) for the contractor/Customer to install.
2. If markers have been removed, the conduit should be located by digging in the general location. If locating the conduit by digging is unsuccessful, call NES Customer Engineering (747-3641) to locate conduits.

! Do not remove or cut off these markers. They are placed when conduit is installed to provide the Customer with a quick and easy means for locating the stub-out. Removal can delay construction.

Figure 58: Conduit Stub-out Marker



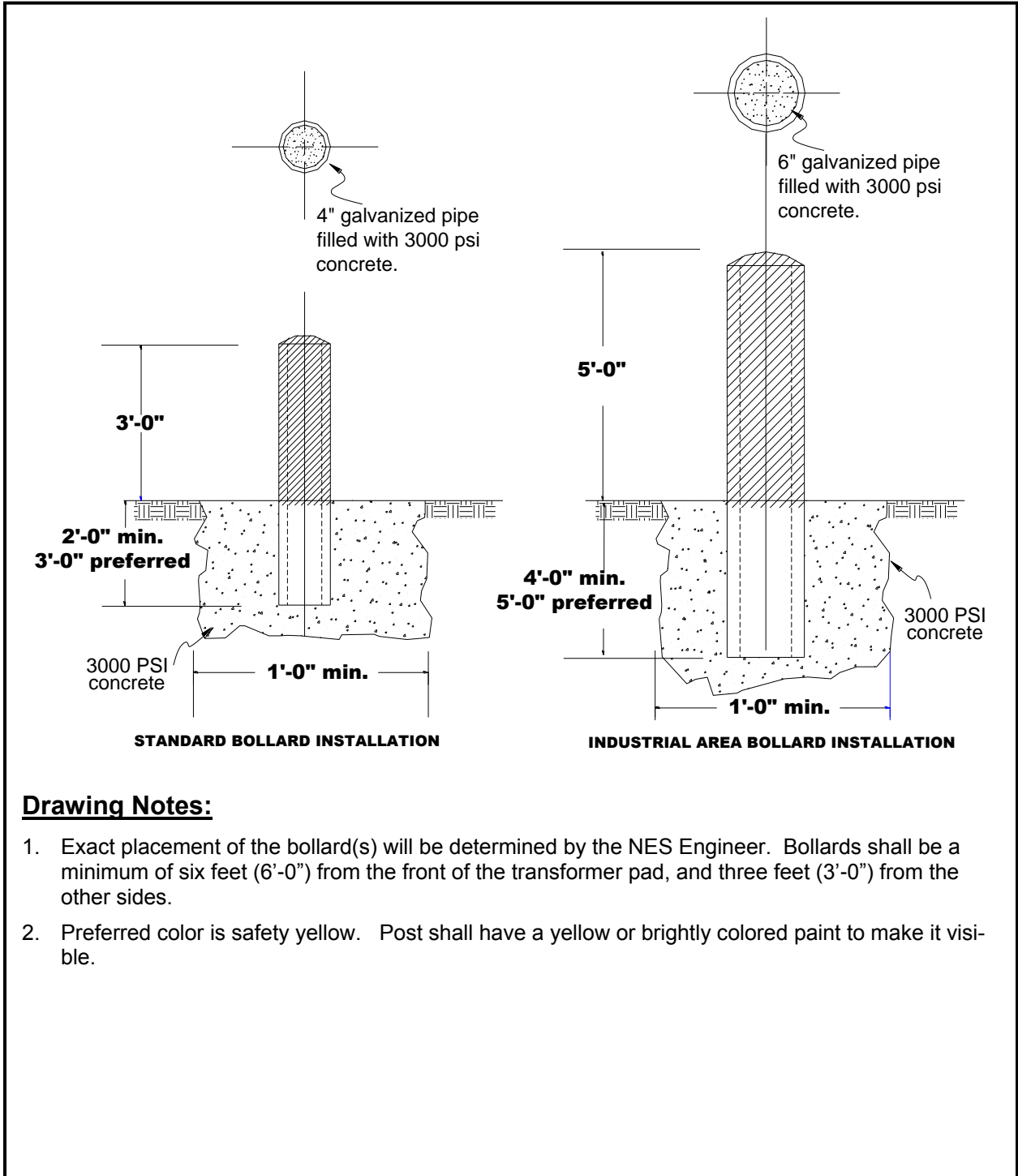

Drawing Notes:

1. Exact placement of the bollard(s) will be determined by the NES Engineer. Bollards shall be a minimum of six feet (6'-0") from the front of the transformer pad, and three feet (3'-0") from the other sides.
2. Preferred color is safety yellow. Post shall have a yellow or brightly colored paint to make it visible.

Figure 59: Bollard/Guard Post

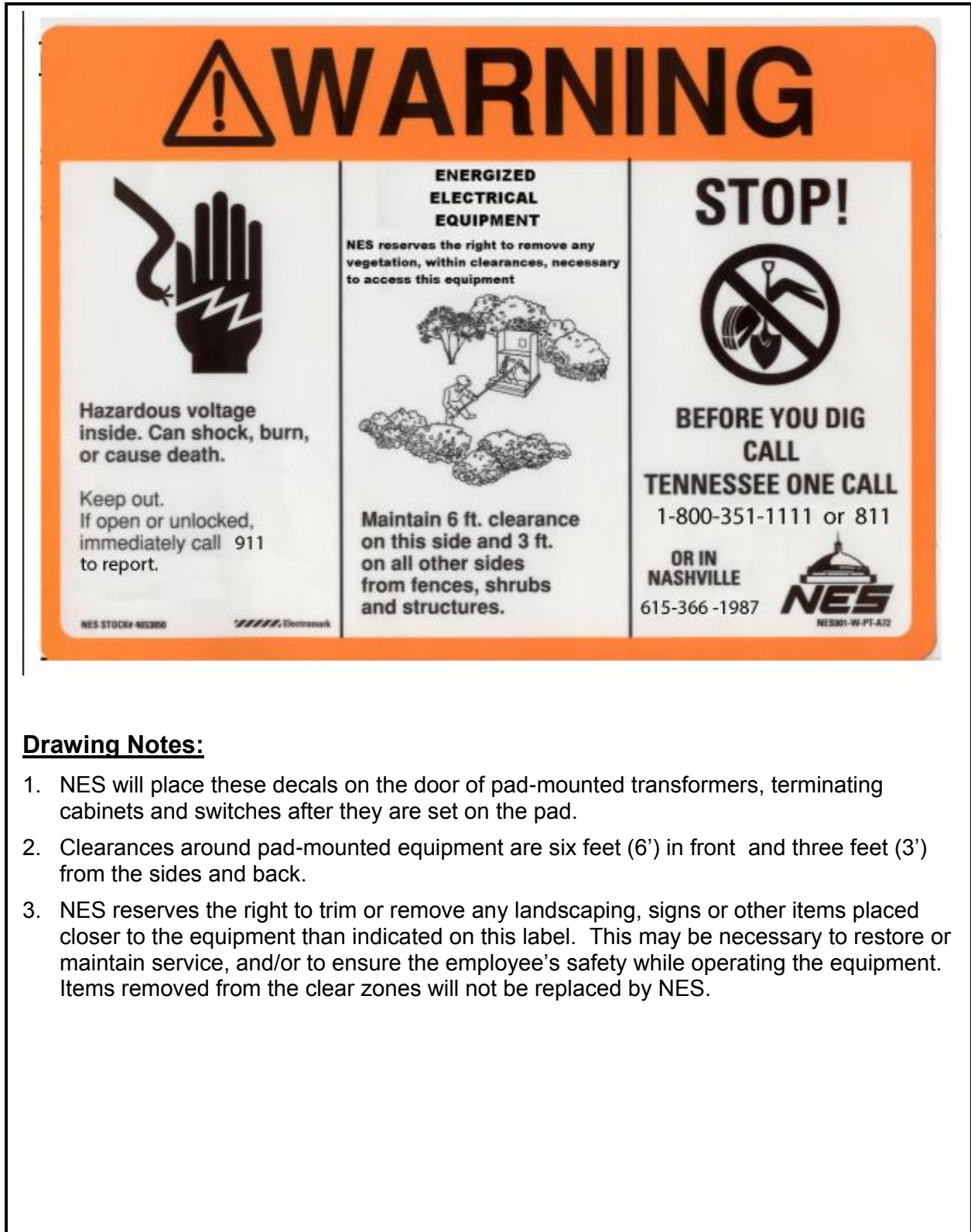

Drawing Notes:

1. NES will place these decals on the door of pad-mounted transformers, terminating cabinets and switches after they are set on the pad.
2. Clearances around pad-mounted equipment are six feet (6') in front and three feet (3') from the sides and back.
3. NES reserves the right to trim or remove any landscaping, signs or other items placed closer to the equipment than indicated on this label. This may be necessary to restore or maintain service, and/or to ensure the employee's safety while operating the equipment. Items removed from the clear zones will not be replaced by NES.

Figure 60: Equipment Warning Label

A

Electric Service Guidelines

Maximum six (6) conduits, includes NES conduits. Maximum diameter of communication conduits is two inches (2"). All conduits must be racked together.

Conduit shall not stub up from or obstruct sidewalk.

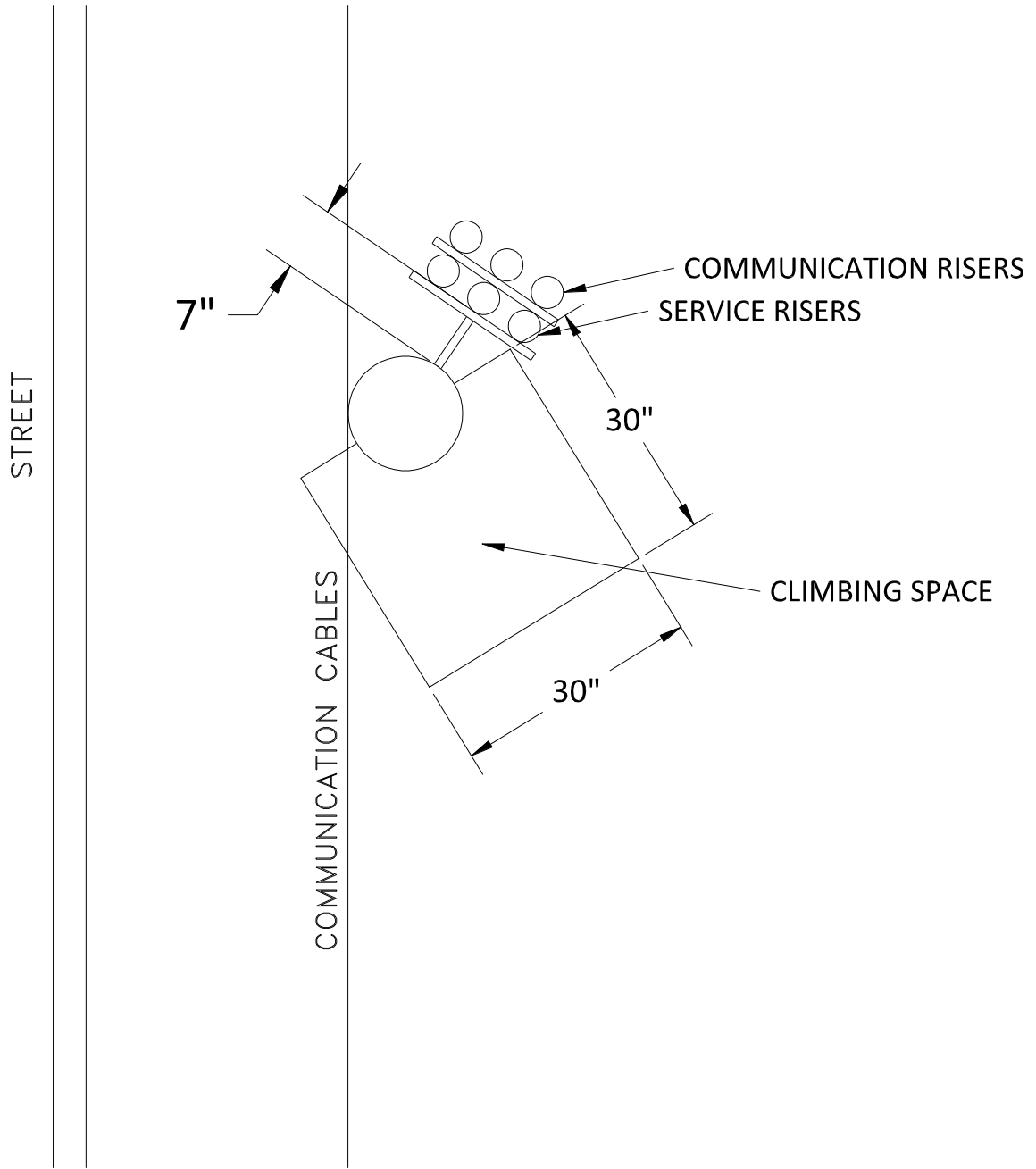

Figure 61: Communication Riser Requirements



NASHVILLE ELECTRIC SERVICE
CONTRACT FOR ELECTRIC SERVICE

| | | |
|----------------------------------|--------------------------------|----------------------------------|
| Succeeds: [REDACTED] | Customer Number: 9999999 | Premise Number: 9999999 |
| Federal ID # (EIN): 99-9999999 | Work Request: 999999999 | Telephone Number: (999) 999-9999 |
| Service Type: Choose an item. | Amps: 0000 | Voltage Choose an item. |
| Mailing Address: [REDACTED] | SIC Code: 9999 | Meter Number: 999999 |
| Electrician: [REDACTED] | General Contractor: [REDACTED] | |
| Special Instructions: [REDACTED] | | |

THIS POWER CONTRACT, including the Terms and Conditions for Demands of 5,000 Kilowatts or Less (see www.nespower.com/commercial_rates/power_contracts.html), is made and entered into this Choose an item, day of Choose an item, 2018 (the "Effective Date"), by and between the METROPOLITAN GOVERNMENT OF NASHVILLE AND DAVIDSON COUNTY, ACTING BY AND THROUGH THE ELECTRIC POWER BOARD OF SAID GOVERNMENT, and operating under the service name of NASHVILLE ELECTRIC SERVICE (hereinafter referred to as "NES"), and

CUSTOMER NAME
(hereinafter referred to as "Customer") (collectively, the "Parties").

WHEREAS, the Parties seek to enter into a POWER CONTRACT (hereinafter, the "Power Contract"), under which the firm electric power and energy will be made available by NES and purchased by Customer for operation of Customer's facility located at:



The contract demand under this Power Contract shall be [REDACTED] kW; [REDACTED] kW on-peak; [REDACTED] kW off-peak.

The contract demand shall only be modified by written consent of both Customer and NES.

The Customer agrees to pay a monthly investment of \$ [REDACTED] to be added to the bill.

The present Rate Schedule for the quantity and rate use of electric energy sold under this Power Contract, Choose an item., is attached hereto and made a part of this Power Contract, as such Rate Schedule may be modified, changed, replaced, or adjusted from time to time as provided under contractual arrangements between NES and the Tennessee Valley Authority. The rate shall continue in effect through the first meter-reading time that falls at least twelve (12) months after the Effective Date.

**THE METROPOLITAN GOVERNMENT OF
NASHVILLE AND DAVIDSON COUNTY,
ACTING BY AND THROUGH THE ELECTRIC
POWER BOARD OF SAID GOVERNMENT**

CUSTOMER NAME

BY: _____
Choose an item., Authorized NES Representative

APPROVED: _____
Choose an item., Supervisor

APPROVED: _____
Choose an item., Manager

Authorized Customer Signature

Print Name

Title

Date



Electric Service Guidelines



Residential Subdivision Application for Service

A) Developer _____ Date submitted ____ / ____ / ____

B) Contact name & number _____

Address of development _____

Name of development/phase _____

Development type Subdivision Condos Townhomes Cottages Apartments

C) Responsible party _____

Authorization letter required from property owner if different from responsible party.

Responsible party address _____

Property owner _____

County tax map # _____

Parcel # _____

Deed of record # _____

D) Type of primary electric service Overhead Underground
 Overhead w/ underground secondary

Number of lots/units _____ Average square footage per unit _____ Stories _____

Type of heat Gas Electric kW of auxiliary heat per unit (if heat pump) _____

If primarily gas heat, any additional electric heat pumps Yes No Tons _____

Average total tons of A/C per unit _____ Water heaters per unit _____ (Electric) _____ (Gas)

Ranges per unit _____ (Electric) _____ (Gas) Clothes dryers per unit _____ (Electric) _____ (Gas)

Sidewalk plans, if applicable Yes No If yes, provide _____ ft. width for grass strip.

Street lighting required per Public Works Yes No

Private lighting along private road Yes No

| | |
|-----------------------|-----------------|
| FOR INTERNAL USE ONLY | |
| WR # _____ | Drawing # _____ |

Residential Subdivision Application continued:



Residential Subdivision Application for Service

The following items must be provided before an estimate can be initiated:

- ACAD civil site drawing in state plane coordinates included with the application (choose one)
 - Yes No Emailed to energyservices@nespower.com Faxed to 615-747-3253

One hardcopy set of Metro approved civil plans accompanied by a Metro Planning Commission approval letter and additional plan types (e.g. architectural, electrical) may be needed.
- Building envelopes shown on civil site drawings
- Proposed or existing easements on final plat (standard 20 ft. PUE adjacent to roads)
- UG High voltage layout when zoning setbacks restrict 20 ft. easements (i.e., SP, UDO, UZO and PUD plans must allow for electrical pad-mounted equipment)
- Fire hydrant locations
- Grading plans
- Storm water plans
- Water & sanitary sewer plans
- Three-phase power requirements
- Multi-unit dwelling proposed meter locations, if applicable
- Meter pedestals required on multi-unit dwelling, if applicable

The following items must be provided before an estimate can be finalized:

- Proposed grading start date _____
- Permanent energize service date _____
- Sidewalk & grass strip details
- Street lighting plans if mandatory by Public Works
- Stream crossings and bridge cross-sections
- Postal plans identify address (multi-family only)
- Three-phase, multi-meter, secondary termination enclosure required. No troughs allowed.
- Dry-type vault room required, if applicable

Additional comments

Customer and street lighting guidelines are available at nespower.com under Builders & Contractors.



Electric Service Guidelines

Pre-construction Form (EXAMPLE COPY) (for projects that require a pre-construction meeting)

Pre-Construction Meeting Information Sheet

Project Name: _____ Work Req. #: _____ Date: _____

| | | |
|-------------------------------|--|--------------|
| Individuals Attending Meeting | | Designer: |
| | | Meter Tech: |
| | | NES Dwg No.: |

- Issued New Electric Service Handbook Issued Construction Drawings to Contractor, Telephone, and CATV Issued: Pad Sketch Manhole Details

Ditch/Conduit Requirements:

- Refer to drawing for conduit sizes and quantity.
- Customer must provide secondary termination enclosure meeting NES specs (See metering section of Electric Service Guidelines: <http://nespower.com/guidelines.html>, click "Electric Service Guidelines").
- Customer should refer to metering section of NES Electric Service Guidelines for all metering requirements.
- Customer is responsible for all necessary tree trimming based on requirements from NES Vegetation Management.
- Minimum 12-inch separation in all directions from other utilities and NES equipment.
- Minimum 3-inch concrete encasement all around conduit or conduits (commercial services with SCH 40 PVC)
- 12-inch concrete encasement (minimum 3 inches under and minimum 9 inches above conduit) where exposed to drainage areas, creeks or other utilities.
- Ditch must be the width specified in the NES Customer Guidelines for New Electric Service, Residential and Commercial Trench Requirements. There must be minimum 30-inch cover over conduit(s). Ditch must be 42" deep, but may be reduced to 36" if NES is the only utility, or to 24" **for solid rock conditions only** with a minimum of 3-inch concrete encasement. (MUST be pre-approved by NES ditch inspector)

Approved by: _____

- No other utilities** can be placed under any NES electrical equipment (such as switches, terminating cabinets, transformers, primary and secondary pull boxes).
- Minimum ten-foot separation between water hydrants and NES equipment.
- Greater than six-foot separation between telephone and CATV pedestals and NES equipment (such as switches, terminating cabinets, transformers, primary and secondary pull boxes).
- Grounding of all other underground facilities to be coordinated by the customer with other providers.
- Divert other utilities away from NES equipment 15 feet before and after coming in proximity of NES equipment.
- Duct bank excavation must be stopped a minimum of 10 feet from the stated riser pole location prior to NES crews installing riser pole.
- Red dyed concrete required in ditch.
- Bollards required to protect padmounted equipment.
- Customer must furnish ground wire: ____ #2 Cu (7 strand) ____ 4/0 Cu (19 strand)

Placement or location of NES equipment:

- Switches, terminating cabinets, and fiberglass transformer pad boxes to be 6 inches above finished grade.
- Fiberglass primary and secondary pull boxes to be installed flush with finished grade.
- Fire Barrier Walls required (check one): 6 ft tall x 8 ft wide or 8 ft tall x 10 ft wide.
- Landscaping: At mature growth must be 6 feet from front of pad-mounted transformers and switches, and 3 feet from other sides.
- It is strictly forbidden to build a roof over, or completely enclose in a building, any pad-mounted equipment such as transformers, switches or trans closures. Proper access for inspection, maintenance and replacement of NES equipment must be maintained.
- All NES equipment to be placed in dedicated easement.
- All surveying provided by developer/contractor.
- Property pins to be staked as specified by NES designer. Notes regarding staking: _____
- The customer is responsible for any cost to relocate NES equipment as a result of changes to the property pins.
- Developer's representative must approve the staked pole locations. Any relocations due to lack of grading or proper positions within the site, will only occur after reimbursement to NES for the relocation.
- An As-Built survey is required prior to energizing the site.

Other items discussed:

Person to contact for inspections or questions:

Name: _____ Phone # _____

Effective 6/1/18



CONTRACTOR PICK-UP MAP

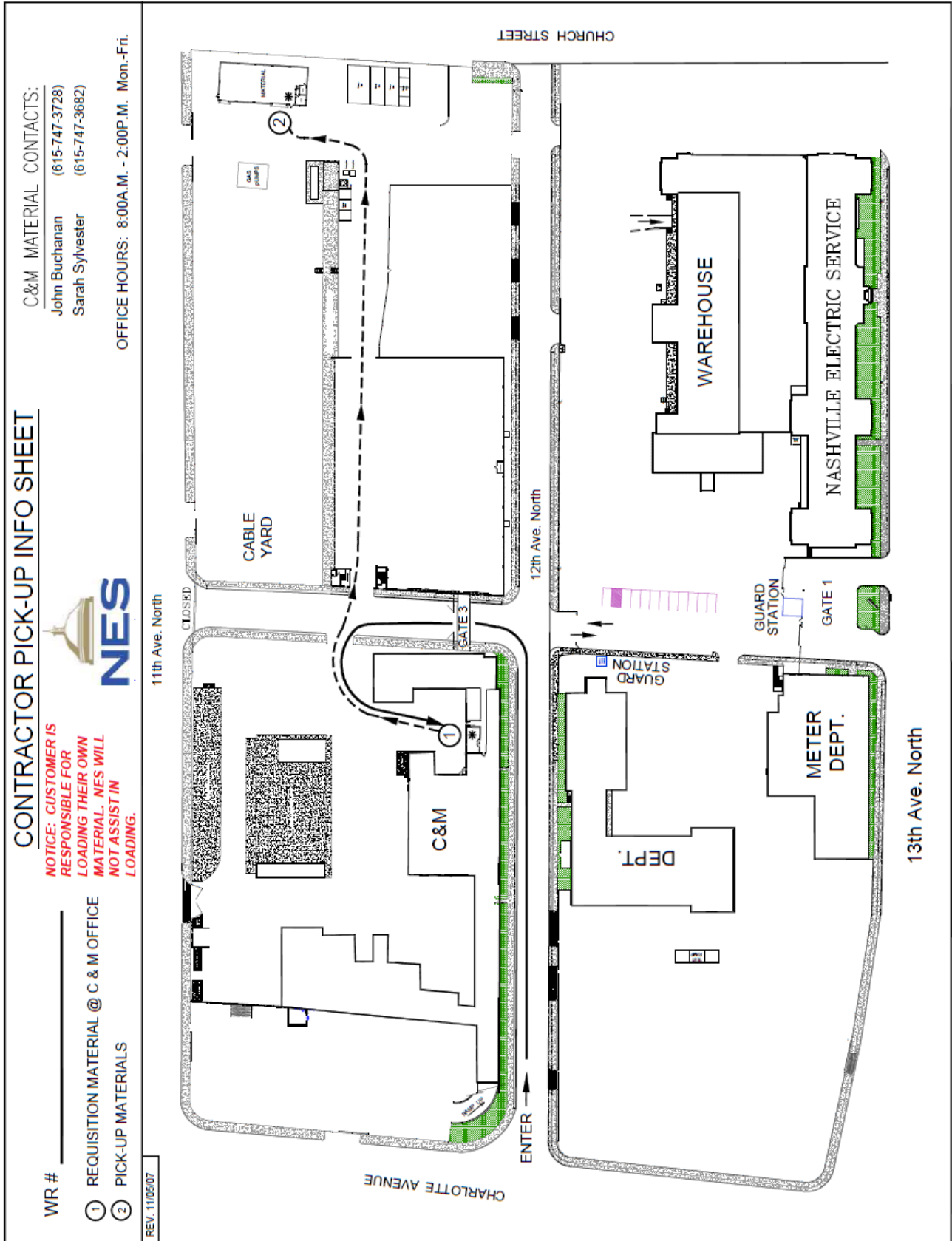



Electric Service Guidelines

OVERVIEW OF CHANGES

(NOT AN EXHAUSTIVE LIST)

- Added OH to UG conversion statement (Page 12)
- Updated commercial pad setback requirements (Page 59)
- Added Vista Switch pads (Page 62)
- Clarified barrier wall requirements (Page 110-111)
- Clarified knuckle boom clearances (Page 97)
- Added Contract for Electric Service (Page 113)

Electric Service Guidelines

Update Reviewers

Ron Davidson (Customer Engineering)
Hank Dunning (Customer Engineering)
Jeremy Hitchcock (Customer Engineering)
Clay Hullett (Meter)
Holly Lively (Customer Engineering)
Chuck Reinitz (C&M)
Wes Suddarth (Customer Engineering)
Tony Williams (C&M)

Approved By:

 Date: 8/2/19

Ron Davidson
Engineering Supervisor
Customer Engineering, Network and Standards

Approved By:

 Date: 8/2/19

Vaughan Charles
Engineering Manager
Customer Engineering